

CHEETAH C4080 and C2880 Hardware User's Manual

HIGH-SPEED, HIGH-RESOLUTION, AND VERSATILE CMOS DIGITAL CAMERAS



CONFIDENTIAL NOTICE:

These products are not intended for use in life support appliances, devices, or systems where malfunction of these products can reasonably be expected to result in personal injury. Imperx customers using or selling these products for use in such applications do so at their own risk and agree to fully indemnify Imperx for any damages resulting from such improper use or sale.

Copyright © 2011, Imperx Inc. All rights reserved. All information provided in this manual is believed to be accurate and reliable. Imperx assumes no responsibility for its use. Imperx reserves the right to make changes to this information without notice. Redistribution of this manual in whole or in part, by any means, is prohibited without obtaining prior permission from Imperx.



Made in USA

Revision History

Rev 0.1	9/01/14	N.Cohen	Initial Pre-Release 1
Rev 0.2	10/28/14	K. Wetzel	Updated Pre-Release 1
Rev 0.3	12/15/14	K. Wetzel	Updated Pre-Release 2
Rev 1.0	02/04/15	K. Wetzel	Production Release
Rev 2.0	02/20/15	K. Wetzel	Updated power and current input values, temp range, terminology in Section 5.2, 5.4, 5.6 and 5.7.
Rev 3.0	3/4/15	K. Wetzel	Updated Table 2.1 & Table 2.2 & Table 2.3
Rev 4.0	6/3/15	K. Wetzel	Trigger exposure in rolling shutter mode p 47, potential image artifacts in WDR p60.
Rev 5.0	6/18/15	K. Wetzel	Update Chapter 4 register locations / functions and Chapter 6: Cheetah Configurator Strobe menu
Rev 6.0 - 6.2	7/7/15	K. Wetzel	Update GUI Screen Shots;
Rev 6.3	12/4/15	K. Wetzel	Added PoCL info
6.4-6.5	2/4/16	K. Wetzel	Added figures and tables,
6.6	4/26/16	K. Wetzel	Corrected 12-bit analog gain description p52
6.7	5/31/16	K. Wetzel	Added additional description around line time register. Also corrected PG granularity in section 2.13.
6.8	7/22/16	K. Wetzel	Updated Mechanical Drawings in 1.6.4, Cheetah photos, Appendix E Power supply schematic; added exposure control info. in 2.7.
Rev 6.9	8/19/2016	M.P	Updated graph/data, adjusted TOC
Rev 7.0	12/12/16	R. Johnston	Added MTBF to camera specification table
Rev 7.0	3/16/2017	R Johnston	Updated Data Format Selector values on page 105
Rev 7.1	7/3/2017	R Johnston	Corrected Trigger De-bounce Time registers, section 3.3.8.5; Corrected Trigger Registers usage, section A.8
Rev 7.1	8/21/17	R Johnston	Removed FFC, section 1.4

TABLE OF CONTENTS

Contents

CHAPTER 1 – INTRODUCTION	10
1.0 CHEETAH FAMILY	11
1.1 GENERAL DESCRIPTION	11
1.2 MAIN CHEETAH FEATURES	13
1.3 CHEETAH SPECIFICATIONS	14
1.3.1 General Information	14
1.3.2 Spectral Sensitivity Curves	17
1.3.3 Bayer Pattern Information	18
1.4 TECHNICAL SPECIFICATIONS	19
1.5 CAMERA CONNECTIVITY	21
1.5.1 CLF (Full) - Camera Link (CL) Output	21
1.5.2 Camera Link Full Signal Mapping	21
1.5.3 Camera Link Physical Layer to Camera Link Receiver Bits	24
1.5.4 Camera Link Bit to Port Bit assignments	24
1.5.4 Camera Link Port assignments based on selected output configuration	28
1.5.4 Camera Power Connector	29
1.6 MECHANICAL, OPTICAL, and ENVIRONMENTAL	30
1.6.1 Mechanical	30
1.6.2 Optical	30
1.6.3 Environmental	31
1.6.4 Mechanical Drawings	32
CHAPTER 2 – CAMERA FEATURES	34
2.1 DUAL VIDEO (FRAME A / FRAME B)	35
2.1.1 Frame A / Frame B Description	35
2.1.2 Dual Video: Frame A / Frame B Switching Options	36
2.2 GLOBAL/ ROLLING SHUTTER	37
2.3 A/D DIGITIZATION	37

2.4 FRAME TIME CONTROL	37
2.4.1 Internal Line and Frame Time Control	37
2.4.2 Camera Output Control	38
2.5 AREA OF INTEREST	39
2.5.1 Overview	39
2.5.2 Horizontal and Vertical Window	39
2.5.3 Factors Impacting Frame Rate	40
2.6 SUBSAMPLING	42
2.6.1 Pixel Averaging	42
2.6.2 Sub-sampling Decimation	43
2.7 EXPOSURE CONTROL	44
2.7.1 Internal Exposure Control - Electronic Shutter	44
2.7.3 External exposure control	47
2.7.4 Variable Frame Time – Programmable Line and Frame Time	47
2.8 CAMERA TRIGGERING	48
2.8.1 Triggering Inputs	48
2.8.2 Acquisition and Exposure Control	48
2.8.3 Triggering modes	49
2.9 STROBES	51
2.10 VIDEO AMPLIFIER GAIN AND OFFSET	52
2.10.1 Analog Domain – manual control	52
2.10.2 Digital Domain – manual control	53
2.11 WIDE DYNAMIC RANGE (WDR)	53
2.11.1 Overview	53
2.11.2 Wide Dynamic Range Controls	59
2.11.3 Initial WDR Setup Recommendations	62
2.11.4 WDR at maximum frame rates (image artifact prevention)	63
2.12 DATA OUTPUT FORMAT	64
2.12.1 Bit Depth	64
2.12.2 Output Taps	66
2.13 PULSE GENERATOR	66
2.14 I/O CONTROL	67
2.14.1 Input / Output Mapping	67
2.14.2 Electrical Connectivity	68
2.15 TEST IMAGE PATTERNS	70

2.15.1 Test Image patterns	70
2.16 WHITE BALANCE AND COLOR CONVERSION	70
2.16.1 White Balance Correction	70
2.17 TRANSFER FUNCTION CORRECTION – USER LUT	71
2.17.1 Standard Gamma Correction	71
2.17.2 User Defined LUT	72
2.18 DEFECTIVE PIXEL CORRECTION	73
2.18.1 Static Pixel Correction	74
2.18.2 Dynamic Pixel Correction	74
2.19 CAMERA INTERFACE	74
2.19.1 Status LED	74
2.19.2 Temperature Monitor	75
2.19.3 Exposure Time Monitor	75
2.19.4 Frame Time Monitor	75
2.19.5 Current image size	75
CHAPTER 3 CAMERA CONFIGURATION	76
3.1 OVERVIEW	77
3.2 CAMERA CONFIGURATION	77
3.2.1 Configuration Memory – parameter FLASH	77
3.2.2 Camera Serial Protocol	78
3.3 CAMERA CONFIGURATION REGISTER DESCRIPTION	81
3.3.1 Startup Procedure	81
3.3.2 Saving and Restoring Settings	81
3.3.3 Retrieving Manufacturing Data	83
3.3.4 Camera Information Registers	85
3.3.5 Frame “A” Workspace Registers	87
3.3.6 Frame “B” Workspace Registers	93
3.3.7 Acquisition Control Registers	98
3.3.8 Triggering Workspace Registers	99
3.3.9 Strobe Control Registers	100
3.3.10 Pulse Generator Workspace Registers	102
3.3.11 Test Pattern Workspace Registers	103
3.3.12 Input/output Workspace Registers	103
3.3.13 Data Output Bit Depth/Format Selector	104
3.3.14 White Balance (WB) Workspace Registers	105
3.3.15 Data Correction Workspace Registers	106

CHAPTER 4 CONFIGURATOR FOR CAMERALINK	108
4.1 OVERVIEW	109
4.2 DISCOVERY PROCEDURE	109
4.3 GRAPHICAL USER INTERFACE	110
4.4 MAIN GUI MENU	111
4.5 VIEW GUI WINDOWS	115
4.6 MENU HELP	116
4.7 PARAMETER WINDOWS	117
4.7.1 Dual Video (Frame A / Frame B) Window	117
4.7.2 Trigger Inputs	123
4.7.3 Pulse Generator	124
4.7.4 Strobe Control And Output Mapping	125
4.7.5 Data Output	127
4.7.6 Color	129
CHAPTER 5 CHEETAH WARRANTY AND SUPPORT	131
5.1 ORDERING INFORMATION	132
5.2 TECHNICAL SUPPORT	132
5.3 WARRANTY	133
APPENDIX A – CAMERA CONFIGURATION REFERENCE	134
A.0 ABBREVIATIONS	135
A.1 SAVING AND RESTORING REGISTERS	135
A.2 CAMERA INFORMATION REGISTERS	135
A.3 FRAME A REGISTERS (Stored in FLASH)	136
A.4 FRAME A WDR REGISTERS	137
A.5 FRAME B REGISTERS (Stored in FLASH)	138
A.6 FRAME B WDR REGISTERS	139

A.7	DUAL VIDEO REGISTERS AND FRAME A/B COMMON REGISTERS	140
A.8	TRIGGER REGISTERS	140
A.9	PULSE GENERATOR REGISTERS	141
A.10	TEST PATTERN REGISTERS	141
A.11	STROBE REGISTERS	141
A.12	INPUT AND OUTPUT REGISTERS	142
A.13	OUTPUT DATA FORMAT REGISTERS	142
A.14	WB AND COLOR CORRECTION REGISTERS	142
A.15	DATA CORRECTION REGISTERS	143
A.16	MANUFACTURING DATA REGISTERS	143
	APPENDIX B – CREATING LOOK UP TABLES	144
B.1	OVERVIEW	145
B.2	USING AN ASCII TEXT EDITOR	145
B.3	USING MICROSOFT EXCEL	146
	APPENDIX C – CREATING DPC AND HPC TABLES	147
C.1	OVERVIEW	148
C.2	USING AN ASCII TEXT EDITOR	148
	APPENDIX D – SOFTWARE INSTALLATION - CL	149
	APPENDIX E – POWER SUPPLIES	151

TABLES AND FIGURES

Figure 1.0a: Global Shutter Description	15	
Figure 1.0b: Rolling Shutter Description	15	
Figure 1.1: CMOS image sensor architecture	17	
Figure 1.2a: KAC-XX040 CMOS mono spectral response. (Monochrome with the cover glass)	18	
Figure 1.2b: KAC-XX040 CMOS typical color spectral response. (Color with Microlens and with cover glass)	18	
Table 1.1: Cheetah General Features	19	
Table 1.2: Cheetah C2880, C4080 Camera Specifications.	20	
Figure 1.3: CLF Camera back panel / Deca, Full, Medium or Base	21	
Figure 1.4a: CLF Camera output connector 1	22	
Table 1.3a: CLF Camera Output Connector 1 – Signal Mapping	22	
Figure 1.4b: CLF Camera output connector 2	23	
Table 1.3b: CLF Camera Output Connector 2 – Signal Mapping	23	
Figure 1.5: Camera Link bit sequence over the physical connection	24	
Table 1.4a: Camera Link Connector #1 (X0-X3)	25	
Table 1.4b: Camera Link Connector #2 (Y0-Y3)	26	
Table 1.4c: Camera Link Connector #2 (Z0-Z3)	27	
Table 1.5a: Image data bit-to-port assignments per the Camera Link specification – Base modes	28	
Table 1.5b: Image data bit-to-port assignments per the Camera Link specification – Medium modes	28	
Table 1.5c: Image data bit-to-port assignments per the Camera Link specification – Full mode	28	
Table 1.5d: Image data bit-to-port assignments per the Camera Link specification – Deca modes	29	
Figure 1.6– Camera Power Connector (Viewed from rear)	29	
Table 1.6: Camera Power Connector Pin Mapping	30	
Figure 1.7a: C4080 Mechanical Drawings (F-Mount)	32	
Figure 1.7b: C2880 Mechanical Drawings (C-Mount)	33	
Figure 2.0: Dual Video Operational Example	35	
Table 2.0: C4080 Frame Rate vs Output Taps	38	
Table 2.1: C2800 Frame Rates vs Output Taps	39	
Figure 2.1: Horizontal and vertical window positioning.	40	
Table 2.2: C4080 AOI frame rate for various AOIs	41	
Table 2.3: C2880 Maximum Frame Rate for various AOIs	42	
Figure 2.2: Monochrome pixel averaging	43	
Figure 2.3: Principle of 4:1 averaging for Bayer Color Filter Pattern	43	
Figure 2.4a: Monochrome sub-sampling example with N = 2 and M = 6.	44	
Figure 2.4b: Color sub-sampling with N=2 and M=4.	44	
Figure 2.5a: Rolling Shutter Mode with 8.33 msec exposure time	46	
Figure 2.5b: Global Shutter with 8.33mS exposure time	46	
Figure 2.5c: Global Shutter Mode with a long exposure period (integration time)	47	
Figure 2.6a: Standard Trigger Mode (Internal Exposure Control)	50	
Figure 2.6b: Standard Trigger Mode (GS Trigger Pulse Width Exposure Control)	51	
Figure 2.7: Strobe positioning with respect to exposure start	52	
Table 2.4: Analog Gain Steps	53	
Table 2.5: Digital Gain Range and Step Size	53	
Figure 2.8b: WDR mode enabled	55	
Table 2.6a: Example of possible output partitioning for 2 intensity slopes	56	
Table 2.6b: Example of output data partitioning for 4 intensity slopes	57	
Figure 2.9: Dual Slope vs Single Slope Integration	58	
Figure 2.10: Output partitioning using Histogram	59	

Table 2.6c: Camera output allocation (%)	60
Figures 2.11a-d: a single knee point demonstration of the WDR function.	62
Figure 2.12: 12-bit internal Digitization with 8, 10 and 12-bit outputs	65
Figure 2.13: 10-bit internal digitization with 8, 10 and 12-bit outputs	66
Table 2.7: Dependency of Line time and frame rate on Output Taps.	66
Figure 2.14: Internal pulse generator	67
Table 2.8a: CHEETAH Input Mapping	67
Table 2.8b: CHEETAH Output Mapping	68
Figure 2.15a: IN1 electrical connection.	68
Figure 2.15b: IN 2 electrical connection	69
Figure 2.15c: OUT 1 LVTTTL electrical connection.	69
Figure 2.15d: OUT 2 Opto-Isolated electrical connection	70
Figure 2.16: Look up table	71
Figure 2.17: Gamma corrected video signal	72
Figure 2.18: Custom LUT	73
Figure 3.1: Serial protocol format	78
Figure 3.2: Normal write cycle	79
Figure 3.3a: Invalid command error	79
Figure 3.3b: Rx timeout error	79
Figure 3.4: Normal read cycle	80
Table 3.0: Current camera temperature values	87
Figure 4.1: Discovery procedure – select port	110
Figure 4.2: CamConfig GUI	111
Figure 4.3: Main Menu	112
Figure 4.4: Defective pixel map	113
Figure 4.5: Command terminal	114
Figure 4.6: View Menu	115
Figure 4.7: Help menu	116
Figure 4.8: About CamConfig.	117
Figure 4.9: Frame A/B Options Menu	118
Figure 4.10: Exposure control window	119
Figure 4.11: AOI Functions	120
Figure 4.12: Subsampling Functions	120
Figure 4.13: Video Amp parameter window	121
Figure 4.14: Wide Dynamic Range Controls	122
Figure 4.15: Trigger parameter window	123
Figure 4.16: Pulse generator window	125
Figure 4.17: Strobe Control window	126
Figure 4.18: Data output window	128
Figure 4.19: Color window	129

Chapter 1

Introduction

This chapter outlines the key features of the CHEETAH camera.

1.0 CHEETAH FAMILY

The CHEETAH series of cameras are built around a robust imaging platform utilizing the latest digital technology and components. The CHEETAH C4080 and C2280 camera series is designed around 2 different CMOS imaging sensors, featuring different resolutions and frame rates and are available in monochrome and color. The Cheetah family currently supports Camera Link Full output and will support CoaXPress output in the future. The CHEETAH series is programmable to support Camera Link Deca, Full, Camera Link Medium and Camera Link Base depending upon the user's needs.

The CHEETAH family list is shown below:

Model	Resolution (H x V)	Speed	Type	Optics	CMOS	Sensor	Supported Outputs
C4080M	4000x3000	67 fps	Mono	4/3"	ONSEMI	KAC-12040	CLF, PoCL/CXP*
C4080C	4000x3000	67fps	Color	4/3"	ONSEMI	KAC-12040	CLF, PoCL/CXP*
C2880M	2832 x 2128	129 fps	Mono	1"	ONSEMI	KAC-6040	CLF, PoCL/CXP*
C2880M	2832 x 2128	129 fps	Color	1"	ONSEMI	KAC-6040	CLF, PoCL/CXP*

Table 1.0 Cheetah Family Overview

1.1 GENERAL DESCRIPTION

The CHEETAH cameras are advanced, intelligent, high-resolution, progressive scan, fully programmable and field upgradeable CMOS cameras. They are built around On Semiconductors area scan CMOS imagers and are feature rich with a built-in image processing engine, low noise, and efficient and optimized internal thermal distribution. The CHEETAH cameras feature a wide range of programmable functions; including, dual video options, extended dynamic range, exposure control, frame rate control, area of interest, subsampling, pixel averaging, gain, offset, several triggering options, strobe output control, transfer function correction, temperature monitoring and user programmable and up-loadable LUT.

The user can program either a rolling shutter for the widest dynamic range or global shutter for superior motion capture. The dual video mode allows two independent acquisition frames (Frame A and Frame B) to be programmed with independent control of exposure time, area of interest (AOI), subsampling, gain, offset and wide dynamic range parameters. Additional controls support a variety of ways to seamless switch between frames.

Exposure time for each frame can be controlled using an internal control or controlled by an external pulse width. Exposure times up to 1 second with 1 μ s increments in rolling shutter mode and 5 μ s increments in global shutter mode are supported. A custom AOI can be programmed for each acquisition frame and subsampling or pixel averaging capabilities are also available. Pixel averaging is a unique feature providing reduced noise and improved signal to noise ratio by blending adjacent pixel information together. Analog gains up to 12

dB (4x) in 12-bit digitization mode and 18 dB (8x) in 10-bit mode are available. Digital gain controls allow further expansion of the low-end signal with 24dB (15.9x) of additional gain available. The wide dynamic range capability features multi-integration times within one frame period compressing bright areas into the available output range and extending the visible dynamic range up to 100db (global shutter mode only) with up to 3 knee points.

A built-in Gamma correction and user-defined LUT capability optimizes the camera's dynamic range even further. Defective and hot pixel corrections can also be applied to correct for pixels that are over-responding or under-responding. Auto-White Balance (AWB) is available in color cameras to correct for color temperature. The cameras have a Camera Link™ interface that includes 8/10/12 bits data transmission with two, four, eight or ten output taps as well as camera control all on one or two cables. The cameras are fully programmable via the Camera Link interface and support Power over Camera Link (PoCL). The adaptability and flexibility of the camera allow it to be used in a wide and diverse range of applications including machine vision, metrology high-definition imaging and surveillance, medical and scientific imaging, intelligent transportation systems, aerial imaging, character recognition, document processing and many more.

1.2 MAIN CHEETAH FEATURES

- Global shutter (GS) or rolling shutter (RS)
- Monochrome or color
- Large 4.7-micron pixels
- Excellent near infrared (NIR) sensitivity
- Ultra-low fixed pattern noise
- Exceptional blooming suppression
- Fast frame rates: 129 fps (C2880), 67 fps (C4080)
- Dual Video Capability
 - Independent control of resolution, gain, offset, pixel averaging, sub-sampling, area of Interest (AOI) and WDR for two acquisition frames
 - Seamless switching between frames
 - Manual, auto or triggered frame switching
- Extended Dynamic Range (WDR)
 - 3 knee points, Piece-wise Linear
- Color and monochrome pixel averaging (4x and 9x)
- Sub-sampling up to 32x
- Areas of Interest
- Analog and Digital Gain Controls
- Offset Control
- Three selectable trigger sources: external, pulse generator or computer
- Built-in pulse generator
- Two programmable output strobes
- Auto-white balance: once, static or tracking
- Image Enhancements
 - Horizontal and vertical flip
- Two 12-bit look-up tables: one LUT pre-programmed with gamma 0.45.
- Defective pixel correction, hot pixel correction
- Two programmable external Inputs and two external outputs.
- Camera Link Base, Medium, Full and Deca support, PoCL support
- Temperature monitor
- Field upgradeable firmware, LUT, DPC, HPC

1.3 CHEETAH SPECIFICATIONS

1.3.1 General Information

A CMOS camera is an electronic device for converting light into an electrical signal. The camera contains a light sensitive element CMOS (Charge Coupled Device) where an electronic representation of the image is formed. The CMOS image sensor consists of a two-dimensional array of sensitive elements – silicon photodiodes, also known as pixels. The photons falling on the CMOS surface create photoelectrons within the pixels, where the number of photoelectrons is linearly proportional to the light level. Although the number of electrons collected in each pixel is linearly proportional to the light level and exposure time, the number of electrons varies with the wavelength of the incident light.

1.3.1.1 Rolling and Global Shutter Description

Cheetah C4080 and C2880 cameras support both global and rolling shutter readout mode. In Global Shutter (GS) mode every pixel starts and stops integration at the same time. This mode is excellent for clean capture of moving scenes without the need for a mechanical shutter. When global shutter mode is used, all pixel data is stored in light shielded regions within each pixel and held there until readout. (Figure 1.0a) In Rolling Shutter (RS) mode each row of the image sensor is captured at a slightly different time. (Figure 1.0b) This can cause distortions in the image, if an object is moving very quickly and the integration time is short with respect to the frame readout time. In rolling shutter mode, pixels in a row are cleared of charge, allowed to integrate for the required exposure time and then the entire row is readout. The resetting of each row ripples through the array and each row is exposed with a slight time delay (equal to the line readout time) relative to the previous row. In RS mode, the transistor within each pixel used to provide global shutter capability is used to provide noise reduction.

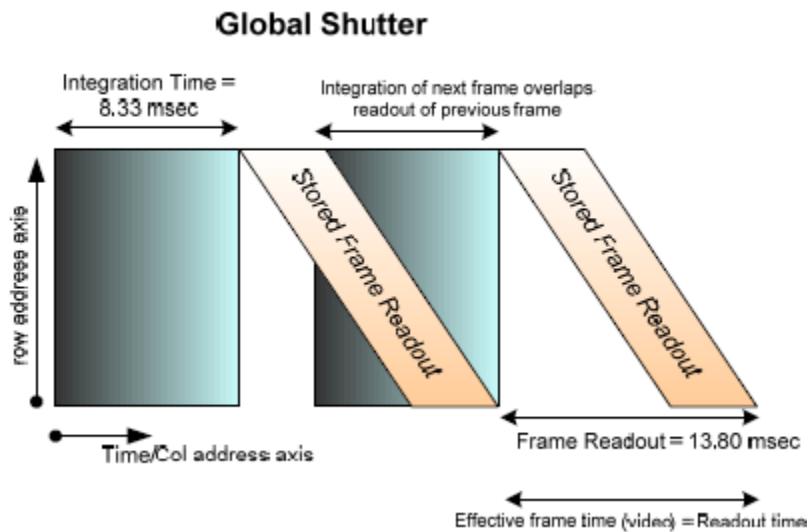

Figure 1.0a: Global Shutter Description

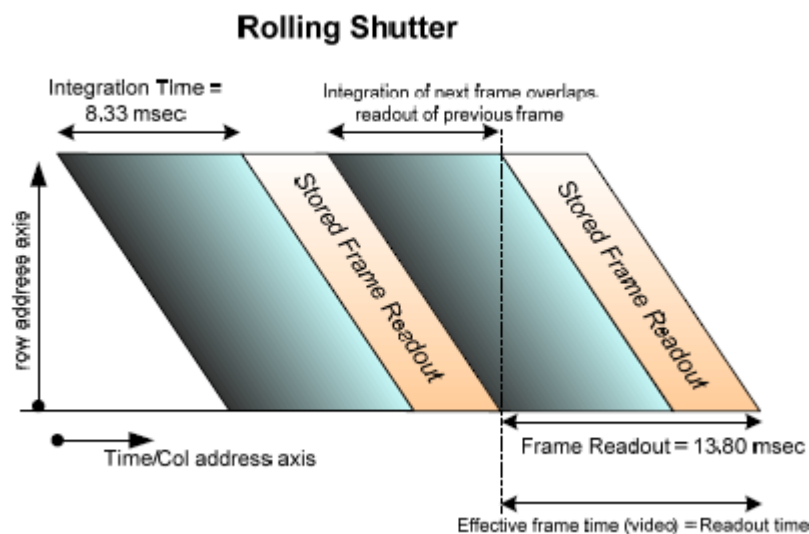

Figure 1.0b: Rolling Shutter Description

1.3.1.2 A/D architecture and Blooming Suppression

The ON Semiconductor KAC-12040 and KAC-06040 image sensors have an analog to digital converter on each column and built-in correction circuits that automatically compensate and correct for fixed pattern noise within the image array. With an A/D converter on each column of the imaging array, digitization occurs within each row time rather than within a readout pixel time and this improves noise performance. Two rows are readout simultaneously (one from the top of the array and one from the

bottom of the array) during one-line time readout. The camera takes care of all the details of re-ordering the lines within frame grabber memory.

The A/D converter architecture allows the user to select between 8, 10 or 12-bit digitization. The Cheetah C4080 supports both 10 and 12-bit digitization. In 12-bit digitization mode, the A/D conversion time is longer than the minimum chip readout time and this reduces maximum frame rates. In 10-bit digitization the A/D conversion time is reduced increasing the maximum frame rate. The image sensor provides up to eight LVDS readout banks and the time to readout one line from the image sensor is less than the time necessary to output the data using Camera Link. The camera compensates for this mismatch in data output rates by adding additional delay at the end of each line.

Each pixel within the imaging array has extremely robust anti-blooming suppression eliminating classic 'black sun' artifacts present in other CMOS imaging arrays. The CMOS readout architecture also eliminates column smearing often seen in traditional CCD image sensors under extremely bright exposure conditions.

The time interval required for all the pixels, from the entire imager, to be clocked out of the CMOS is called a frame. To generate a color image a set of color filters (Red, Green, and Blue) arranged in a "Bayer" pattern, are placed over the pixels. The starting color is Green. Figure 1.1 shows the CMOS image sensor architecture. Figures 1.2a,b show the camera's spectral response.

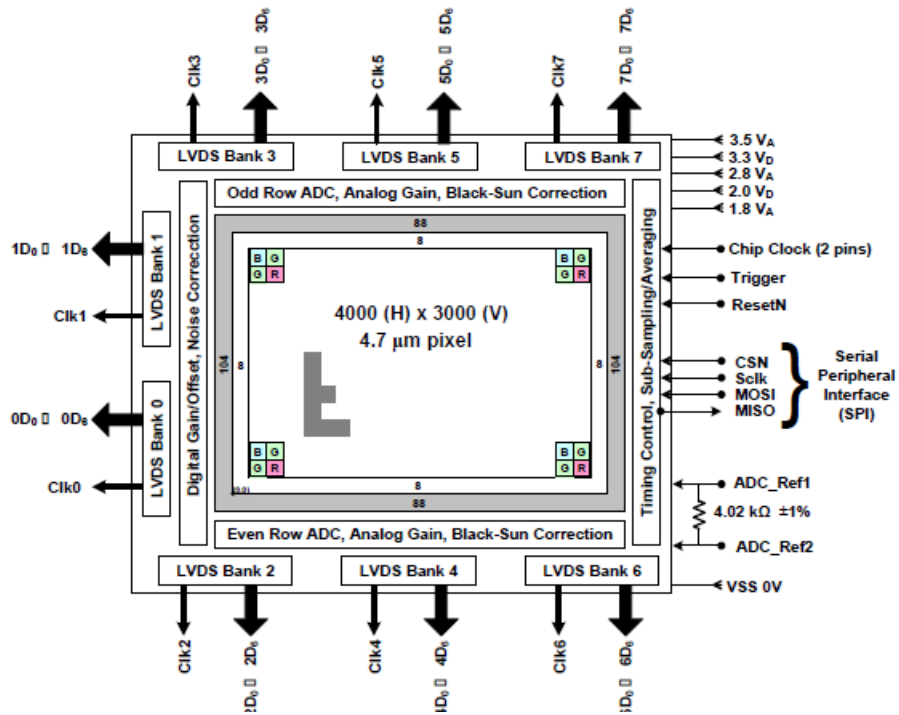

Figure 1.1: CMOS image sensor architecture

1.3.2 Spectral Sensitivity Curves

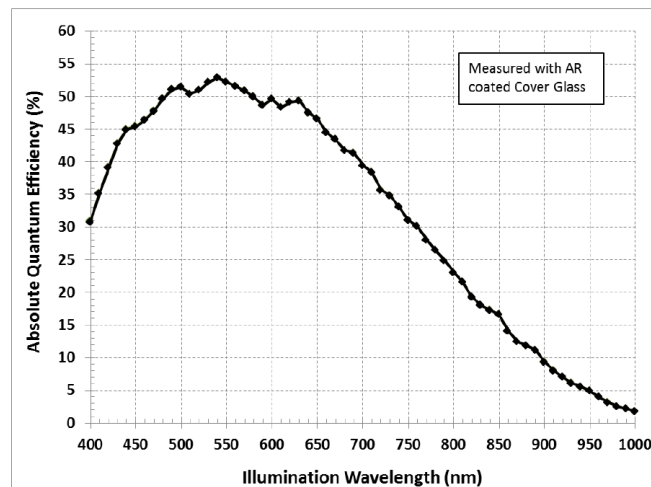

Figure 1.2a: KAC-XX040 CMOS mono spectral response.
(Monochrome with the cover glass)

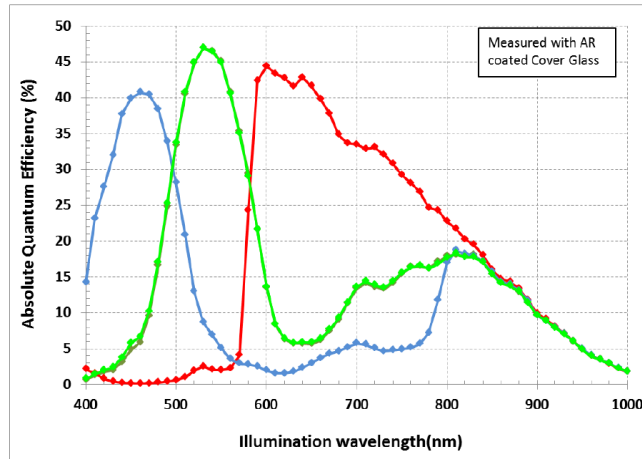

Figure 1.2b: KAC-XX040 CMOS typical color spectral response.
(Color with microlens and cover glass)

1.3.3 Bayer Pattern Information

CHEETAH is available with Monochrome or Color CMOS imager. To generate a color image a set of color filters (Red, Green, and Blue) arranged in a “Bayer” pattern, are placed over the pixels. The starting color is Green.

1.4 TECHNICAL SPECIFICATIONS

The following Tables describe features and specifications that relate to all CHEETAH CLF and CXP cameras.

Features / Specifications	C4080/C2880
Shutter Operation	Global or Rolling
Dual Video Operation	Independent Acquisition Frames
Frame Time (Long int.)	up to 1 sec
Subsampling	Up to 32x
Pixel Averaging (color and mono)	4x, 9x
Wide Dynamic Range	Optional
Auto-White Balance	Yes
Test Image	Static, Dynamic
Mirror image (H Mirror)	Yes
Vertical image (V Mirror)	Yes
Image Overlay	Crosshairs at Optical Center
Defective pixel correction	Static, Dynamic, User DPM,
Hot pixel correction	Static, Dynamic, User HPM
Inputs	1 LVTTTL / 1 Opto-coupled
Outputs	1 5v TTL / 1 Opto-coupled
Triggers	Programmable Rising/Falling, De-bounce
Pulse Generator	Yes
In-camera Image Processing	2 LUTs
Camera housing	Aluminum
Supply voltage range	10 V to 15 V DC
Upgradeable firmware	Yes
Upgradeable LUT, DPM	Yes
Operating	- 40.0 to + 85.0 deg C
Environmental – Storage	- 50.0 to + 90.0 deg C
Vibration, Shock	
Relative humidity	10% to 90% non-condensing

Table 1.1: Cheetah General Features

Specifications	C4080	C2880
Active image resolution	4000x3000	2832x2128
Active image area (H, V)	18.8mm x 14.1mm 23.5mm Diagonal	13.1mm x 10.0mm 16.65mm Diagonal
Pixel size	4.7 μ m	4.7 μ m
Video output	Digital, 8/10/12-bit	Digital, 8/10/12-bit
Output structure	10-Tap	10-Tap
Data clock	80 MHz	80 MHz
Camera interface	DECA/Full/Medium or Base CL	DECA/Full/Medium or Base CL
Connector	HDR (26-pin mini CL)	HDR (26-pin mini CL)
Maximum frame rate	27 fps (12-bit), 67fps (8-bit)	50 fps (12-bit), 129 fps (8-bit)
DR rolling/global	72 (RS) /56 (GS) dB	72 (RS) /56 (GS) dB
Dual Video Frame Control (FRAME A / FRAME B)	Independent control of Resolution, Exposure Time, Gain, Area of Interest, Subsampling, Pixel Averaging, Wide Dynamic Range	Independent control of Resolution, Exposure Time, Gain, Area of Interest, Subsampling, Pixel Averaging, Wide Dynamic Range
Shutter speed	1 μ s to 1sec (RS), 5 μ s to 1 sec (GS)	1 μ s to 1 sec (RS), 5 μ s to 1 sec (GS)
Area of Interest	One per Frame	One per Frame
Analog gain	0 to 12dB (12-bit), 0 to 18dB (8 & 10-bit)	0 to 12dB (12-bit) 0 to 18dB (8 & 10-bit)
Digital gain	0 to 24dB	0 to 24dB
Black level offset	0 to 2048, 1/step	0 to 2048 1/step
User LUT	2 LUTs: Gamma, User LUT	2 LUTs: Gamma, User LUT
Dual Frame Switching Control	Manual, Auto, External Trigger	Manual, Auto, External Trigger
Hardware trigger	Asynchronous	Asynchronous
Strobe Modes	Programmable Width, Delay	Programmable Width, Delay
Trigger Sources	External, Pulse Generator, Computer	External, Pulse Generator, Computer
Trigger features	Rising/Falling edge, De-glitch, Delay, Strobe	Rising/Falling edge, De-glitch, Delay, Strobe
Size (W x H x L) - CLB	(72.0 x 72.0 x 39.8) mm	(72.0 x 72.0 x 39.8) mm
Weight	384 g	TBD
Lens Mount	F-Mount, C-Mount, 4/3" format	C-Mount- 1" format
Power	12V / 0.34 A	TBD
MTBF	MTBF > 323,000 hours @40°C	MTBF > 323,000 hours @40°C

Table 1.2: Cheetah C2880, C4080 Camera Specifications.

1.5 CAMERA CONNECTIVITY

1.5.1 CLF (Full) - Camera Link (CL) Output

The interface between the CHEETAH cameras and outside equipment is done via 2 connectors and one LED, located on the back panel of the camera – Figure 1.3.

1. Two camera outputs – standard Full Camera Link Mini connectors provides data, sync, control, and serial interface and PoCL power.
2. Male 12-pin Power Connector – provides power and I/O interface.
3. USB type B programming/SPI connector.
4. Status LED – indicates the status of the camera – refer to Status LED section.
5. Model / Serial Number – shows camera model and serial number.



Figure 1.3: CLF Camera back panel / Deca, Full, Medium or Base

1.5.2 Camera Link Full Signal Mapping

Camera data output is compliant with Deca (80-bit), Full (64-bit), Medium (48-bit) and Base (24-bit) Camera Link standard and includes 12VDC Power over Camera Link (PoCL), up to 80 data bits, 4 sync signals (LVAL, FVAL, DVAL and User Out), 1 reference clock, 2 external inputs CC1, CC2 and a bi-directional serial interface. The camera link output connectors are shown in Figure 1.4a and 1.4b, and the corresponding bit and port mapping is described below.

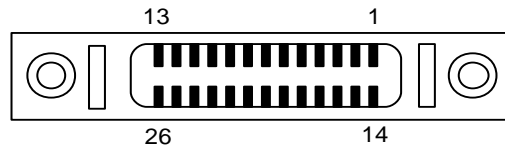

Figure 1.4a: CLF Camera output connector 1

Cable Name	Pin	CL Signal	Type	Description
Base Wire	1	12 VDC Power	Power	PoCL Power Base
Base Wire	14	Power Return	Ground	PoCL Ground
- PAIR 1	2	- X 0	LVDS - Out	Camera Link Channel Tx
+ PAIR 1	15	+ X 0	LVDS - Out	Camera Link Channel Tx
- PAIR 2	3	- X 1	LVDS - Out	Camera Link Channel Tx
+ PAIR 2	16	+ X 1	LVDS - Out	Camera Link Channel Tx
- PAIR 3	4	- X 2	LVDS - Out	Camera Link Channel Tx
+ PAIR 3	17	+ X 2	LVDS - Out	Camera Link Channel Tx
- PAIR 4	5	- X CLK	LVDS - Out	Camera Link Clock Tx
+ PAIR 4	18	+ X CLK	LVDS - Out	Camera Link Clock Tx
- PAIR 5	6	- X 3	LVDS - Out	Camera Link Channel Tx
+ PAIR 5	19	+ X 3	LVDS - Out	Camera Link Channel Tx
+ PAIR 6	7	+ SerTC	LVDS - In	Serial Data Receiver
- PAIR 6	20	- SerTC	LVDS - In	Serial Data Receiver
- PAIR 7	8	- SerTFG	LVDS - Out	Serial Data Transmitter
+ PAIR 7	21	+ SerTFG	LVDS - Out	Serial Data Transmitter
- PAIR 8	9	- CC 1	LVDS - In	User Selectable Input
+ PAIR 8	22	+ CC 1	LVDS - In	User Selectable Input
+ PAIR 9	10	+ CC2	LVDS - In	User Selectable Input
- PAIR 9	23	- CC2	LVDS - In	User Selectable Input
- PAIR 10	11	N/C	N/C	N/C
+ PAIR 10	24	N/C	N/C	N/C
+ PAIR 11	12	N/C	N/C	N/C
- PAIR 11	25	N/C	N/C	N/C
Base Wire	13	Power Return	Ground	PoCL Ground
Base Wire	26	12 VDC Power	Power	PoCL Power Base

Table 1.3a: CLF Camera Output Connector 1 – Signal Mapping

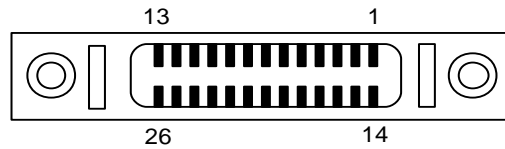

Figure 1.4b: CLF Camera output connector 2

Cable Name	Pin	CL Signal	Type	Description
Base Wire	1	12 VDC Power	Power	PoCL Power Base
Base Wire	14	Power Return	Ground	PoCL Ground
- PAIR 1	2	- Y 0	LVDS - Out	Camera Link Channel Tx
+ PAIR 1	15	+ Y 0	LVDS - Out	Camera Link Channel Tx
- PAIR 2	3	- Y 1	LVDS - Out	Camera Link Channel Tx
+ PAIR 2	16	+ Y 1	LVDS - Out	Camera Link Channel Tx
- PAIR 3	4	- Y 2	LVDS - Out	Camera Link Channel Tx
+ PAIR 3	17	+ Y 2	LVDS - Out	Camera Link Channel Tx
- PAIR 4	5	- Y CLK	LVDS - Out	Camera Link Clock Tx
+ PAIR 4	18	+ Y CLK	LVDS - Out	Camera Link Clock Tx
- PAIR 5	6	- Y 3	LVDS - Out	Camera Link Channel Tx
+ PAIR 5	19	+ Y 3	LVDS - Out	Camera Link Channel Tx
+ PAIR 6	7	unused	LVDS - In	Serial Data Receiver
- PAIR 6	20	unused	LVDS - In	Serial Data Receiver
- PAIR 7	8	- Z 0	LVDS - Out	Camera Link Channel Tx
+ PAIR 7	21	+ Z 0	LVDS - Out	Camera Link Channel Tx
- PAIR 8	9	- Z 1	LVDS - Out	Camera Link Channel Tx
+ PAIR 8	22	+ Z 1	LVDS - Out	Camera Link Channel Tx
+ PAIR 9	10	- Z 2	LVDS - Out	Camera Link Channel Tx
- PAIR 9	23	+ Z 2	LVDS - Out	Camera Link Channel Tx
- PAIR 10	11	-Z CLK	LVDS - Out	Camera Link Clock Tx
+ PAIR 10	24	+ Z CLK	LVDS - Out	Camera Link Clock Tx
+ PAIR 11	12	- Z 3	LVDS - Out	Camera Link Channel Tx
- PAIR 11	25	+Z 3	LVDS - Out	Camera Link Channel Tx
Base Wire	13	Power Return	Ground	PoCL Ground
Base Wire	26	12 VDC Power	Power	PoCL Power Base

Table 1.3b: CLF Camera Output Connector 2 – Signal Mapping

1.5.3 Camera Link Physical Layer to Camera Link Receiver Bits

The timing diagram below describes how the Camera Link bits are transmitted over the physical link. In the timing diagram below, X0, X1, X2 and X3 are the physical connections. Seven data packets of four bits each are sent during each clock cycle and provide the 28 Camera Link Bits. In the figure 1.5 below, Camera Link bits 0, 8, 19 and 27 are received over X0 to X3 in the first transfer and bits 1, 9, 20 and 5 are received in the second transfer cycle. The timing for Y0 to Y3 and Z0 to Z3 physical connections is the same as X0 to X3.

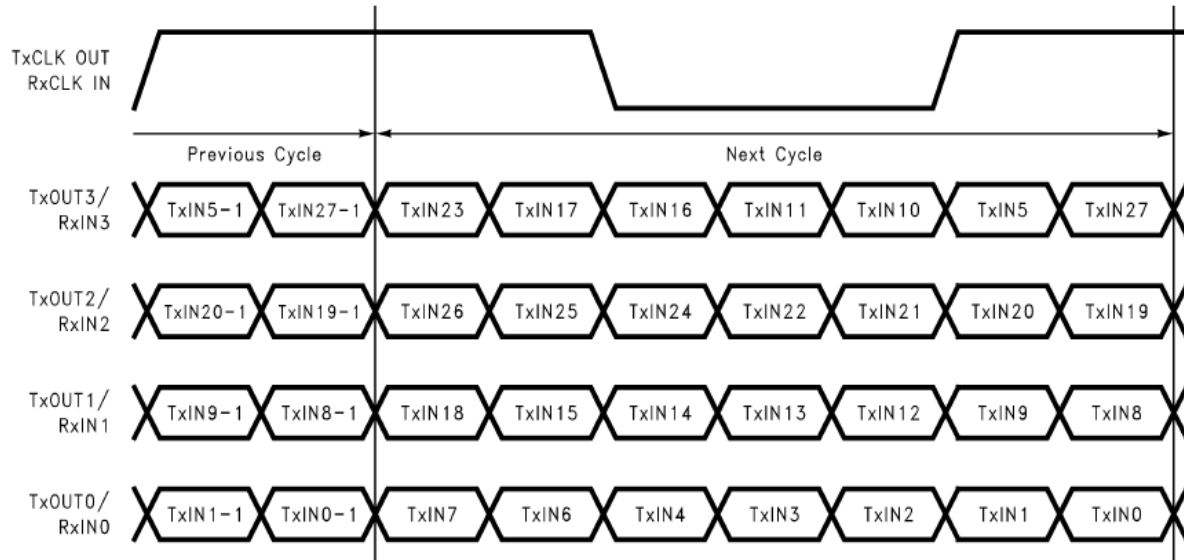

Figure 1.5: Camera Link bit sequence over the physical connection

1.5.4 Camera Link Bit to Port Bit assignments

Tables 1.4a-c describe how the Camera Link Receiver bits received from X0-X3, Y0-Y3 and Z0-Z3 physical connections on CL connectors #1 and are translated into the Camera Link Port bits based on the selected Camera Link Configuration: Base, Medium, Full or Deca.

Camera Link X0-X3			
CL_RCVR_Bits	Base	10tap8bit	8tap10bit
		Deca	Deca
0	A0	A0	A0
1	A1	A1	A1
2	A2	A2	A2
3	A3	A3	A3
4	A4	A4	A4
5	A7	A5	A7
6	A5	A6	A5
7	B0	A7	B0
8	B1	B0	B1
9	B2	B1	B2
10	B6	B2	B6
11	B7	B3	B7
12	B3	B4	B3
13	B4	B5	B4
14	B5	B6	B5
15	C0	B7	C0
16	C6	C0	C6
17	C7	C1	C7
18	C1	C2	C1
19	C2	C3	C2
20	C3	C4	C3
21	C4	C5	C4
22	C5	C6	C5
23	SPR	C7	I1
24	LVAL	LVAL	LVAL
25	FVAL	FVAL	FVAL
26	DVAL	D0	I0
27	A6	D1	A6

Table 1.4a: Camera Link Connector #1 (X0-X3)

Camera Link Y0-Y3			
CL_RCVR_Bits	Med	10tap8bit	8tap10bit
		Deca	Deca
0	D0	D2	D0
1	D1	D3	D1
2	D2	D4	D2
3	D3	D5	D3
4	D4	D6	D4
5	D7	D7	D7
6	D5	E0	D5
7	E0	E1	E0
8	E1	E2	E1
9	E2	E3	E2
10	E6	E4	E6
11	E7	E5	E7
12	E3	E6	E3
13	E4	E7	E4
14	E5	F0	E5
15	F0	F1	F0
16	F6	F2	F6
17	F7	F3	F7
18	F1	F4	F1
19	F2	F5	F2
20	F3	F6	F3
21	F4	F7	F4
22	F5	G0	F5
23	SPR	G1	I4
24	LVAL	G2	LVAL
25	FVAL	G3	I2
26	DVAL	G4	I3
27	D6	LVAL	D6

Table 1.4b: Camera Link Connector #2 (Y0-Y3)

Camera Link Z0-Z3			
CL_RCVR_Bits	Full	10tap8bit	8tap10bit
		Deca	Deca
0	G0	G5	G0
1	G1	G6	G1
2	G2	G7	G2
3	G3	H0	G3
4	G4	H1	G4
5	G7	H2	G7
6	G5	H3	G5
7	H0	H4	H0
8	H1	H5	H1
9	H2	H6	H2
10	H6	H7	H6
11	H7	I0	H7
12	H3	I1	H3
13	H4	I2	H4
14	H5	I3	H5
15	-	I4	I5
16	-	I5	J3
17	-	I6	J4
18	-	I7	I6
19	-	J0	I7
20	-	J1	J0
21	-	J2	J1
22	-	J3	J2
23	SPR	J4	J7
24	LVAL	J5	LVAL
25	FVAL	J6	J5
26	DVAL	J7	J6
27	G6	LVAL	G6

Table 1.4c: Camera Link Connector #2 (Z0-Z3)

1.5.4 Camera Link Port assignments based on selected output configuration

1x8	2x8	1x10	2x10	1x12	2x12	4x8	4x10	4x12	8x8	10x8	8x10	MODE
✓	✓	✓	✓	✓	✓							Base
						✓	✓	✓				Medium
									✓			Full
										✓	✓	Deca

Port C								Port B								Port A								MODE
c7	c6	c5	C4	c3	c2	c1	c0	b7	b6	b5	b4	b3	b2	b1	b0	a7	a6	a5	a4	a3	a2	a1	a0	
																A7	A6	A5	A4	A3	A2	A1	A0	1x8
								B7	B6	B5	B4	B3	B2	B1	B0	A7	A6	A5	A4	A3	A2	A1	A0	2x8
														A9	A8	A7	A6	A5	A4	A3	A2	A1	A0	1x10
										B9	B8			A9	A8	A7	A6	A5	A4	A3	A2	A1	A0	2x10
												A11	A10	A9	A8	A7	A6	A5	A4	A3	A2	A1	A0	1x12
								B7	B6			A11	A10	A9	A8	A7	A6	A5	A4	A3	A2	A1	A0	2x12

Table 1.5a: Image data bit-to-port assignments per the Camera Link specification – Base modes

Port C Port F								Port B Port E								Port A Port D								MODE
c7	c6	c5	c4	c3	c2	c1	c0	b7	b6	b5	b4	b3	b2	b1	b0	a7	a6	a5	a4	a3	a2	a1	a0	
f7	f6	f5	f4	f3	f2	f1	f0	e7	e6	e5	e4	e3	e2	e1	e0	d7	d6	d5	d4	d3	d2	d1	d0	4x8
C7	C6	C5	C4	C3	C2	C1	C0	B7	B6	B5	B4	B3	B2	B1	B0	A7	A6	A5	A4	A3	A2	A1	A0	
																D7	D6	D5	D4	D3	D2	D1	D0	
										B9	B8			A9	A8	A7	A6	A5	A4	A3	A2	A1	A0	4x10
								C7	C6	C5	C4	C3	C2	C1	C0	D7	D6	D5	D4	D3	D2	D1	D0	
												A11	A10	A9	A8	A7	A6	A5	A4	A3	A2	A1	A0	4x12
								D11	D10	D9	D8	C11	C10	C9	C8	C7	C6	C5	C4	C3	C2	C1	C0	

Table 1.5b: Image data bit-to-port assignments per the Camera Link specification – Medium modes

Port C Port F								Port B Port E								Port A Port D								MODE
---								Port H								Port G								
c7	c6	c5	c4	c3	c2	c1	c0	b7	b6	b5	b4	b3	b2	b1	b0	a7	a6	a5	a4	a3	a2	a1	a0	
f7	f6	f5	f4	f3	f2	f1	f0	e7	e6	e5	e4	e3	e2	e1	e0	d7	d6	d5	d4	d3	d2	d1	d0	8x8
C7	C6	C5	C4	C3	C2	C1	C0	B7	B6	B5	B4	B3	B2	B1	B0	A7	A6	A5	A4	A3	A2	A1	A0	
								H7	H6	H5	H4	H3	H2	H1	H0	G7	G6	G5	G4	G3	G2	G1	G0	
								E7	E6	E5	E4	E3	E2	E1	E0	D7	D6	D5	D4	D3	D2	D1	D0	
								H7	H6	H5	H4	H3	H2	H1	H0	G7	G6	G5	G4	G3	G2	G1	G0	

Table 1.5c: Image data bit-to-port assignments per the Camera Link specification – Full mode

Port C								Port B								Port A															
Port F								Port E								Port D															
Port I								Port H								Port G															
---								---								Port J															
c7	c6	c5	c4	c3	c2	c1	c0	b7	b6	b5	b4	b3	b2	b1	b0	a7	a6	a5	a4	a3	a2	a1	a0								
f7	f6	f5	f4	f3	f2	f1	f0	e7	e6	e5	e4	e3	e2	e1	e0	d7	d6	d5	d4	d3	d2	d1	d0								
i7	i6	i5	i4	i3	i2	i1	i0	h7	h6	h5	h4	h3	h2	h1	h0	g7	g6	g5	g4	g3	g2	g1	g0								
																j7	j6	j5	j4	j3	j2	j1	j0	MODE							
C7	C6	C5	C4	C3	C2	C1	C0	B7	B6	B5	B4	B3	B2	B1	B0	A7	A6	A5	A4	A3	A2	A1	A0	10x8							
F7	F6	F5	F4	F3	F2	F1	F0	E7	E6	E5	E4	E3	E2	E1	E0	D7	D6	D5	D4	D3	D2	D1	D0								
I7	I6	I5	I4	I3	I2	I1	I0	H7	H6	H5	H4	H3	H2	H1	H0	G7	G6	G5	G4	G3	G2	G1	G0								
																J7	J6	J5	J4	J3	J2	J1	J0								
C9	C8	C7	C6	C5	C4	C3	C2	B9	B8	B7	B6	B5	B4	B3	B2	A9	A8	A7	A6	A5	A4	A3	A2	8x10							
F9	F8	F7	F6	F5	F4	F3	F2	E9	E8	E7	E6	E5	E4	E3	E2	D9	D8	D7	D6	D5	D4	D3	D2								
D1	D0	C1	C0	B1	B0	A1	A0	H9	H8	H7	H6	H5	H4	H3	H2	G9	G8	G7	G6	G5	G4	G3	G2								
																H1	H0	G1	G0	F1	F0	E1	E0								

Table 1.5d: Image data bit-to-port assignments per the Camera Link specification – Deca modes

1.5.4 Camera Power Connector

The male 12-pin Hirose connector provides power and all external input/output signals supplied to the camera. Refer to Fig 1.5 for connector pin-outs. Refer to Table 1.6 for corresponding pin mapping. The connector is a male HIROSE type miniature locking receptacle #HR10A-10R-12PB (71). The optionally purchased power supply is shipped with a power cable which terminates in a female HIROSE plug #HR10A-10P-12S(73).

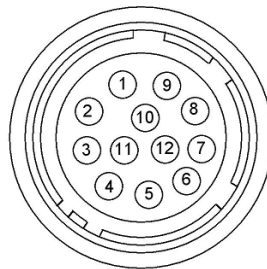

Figure 1.6– Camera Power Connector (Viewed from rear)

Pin	Signal	Type	Description
1	12 VDC Return	Ground Return	12 VDC Main Power Return
2	+ 12 VDC	Power - Input	+ 12 VDC Main Power
3	NC	-NC	No Connect
4	NC	NC	No Connect
5	GP OUT 2	Opto- Switch contact 2	General Purpose Output 2-
6	GP Out 1 RTN	TTL Ground Return	General Purpose Output 1 Return
7	GP OUT 1	TTL OUT 1	General Purpose Output 1
8	GP IN 1	Opto-isolated IN 1	General Purpose Input 1
9	GP IN 2	TTL/LVTTL IN 2	General Purpose Input 2
10	GP IN 1 Return	Ground Return IN1	General Purpose Input 1 Return
11	GP IN 2 Return	LVTTL Ground Return IN2	General Purpose Input 2 Return
12	GP OUT 2	Opto-Switch contact 1	General Purpose Output 2+

Table 1.6: Camera Power Connector Pin Mapping

1.6 MECHANICAL, OPTICAL, and ENVIRONMENTAL

1.6.1 Mechanical

The camera housing is manufactured using high quality zinc-aluminum alloy and anodized aluminum. For maximum flexibility, the camera has eight (8) M3X0.5mm mounting screws, located towards the front and the back. An additional plate with ¼-20 UNC (tripod mount) and hardware is shipped with each camera. Mechanical drawings for C4080 and C2880 Camera Link output cameras are found in Figures 1.7a to 1.7b below. All dimensions are in millimeters.

1.6.2 Optical

The C4080 camera (72 x 72) mm cross-section comes with an adapter for F-mount lenses, which have a 46.50 mm back focal distance and the C2880 camera (also 72 x 72) mm cross-section comes with an adapter for C-Mount lenses which have a 17.5 mm.

The camera performance and signal to noise ratio depends on the illumination (amount of light) reaching the sensor and the exposure time. Always try to balance these two factors. Unnecessarily long exposure will increase the amount of noise and thus decrease the signal to noise ratio.

The cameras are very sensitive in the IR spectral region. All color cameras have an IR cut-off filter installed. The monochrome cameras are without IR filter. If necessary, an IR filter (1 mm thickness or less) can be inserted under the front lens bezel.

CAUTION NOTE

1. Avoid direct exposure to a high intensity light source (such as a laser beam). This may damage the camera optical sensor!
2. Avoid foreign particles on the surface of the imager.

1.6.3 Environmental

The camera is designed to operate from -40° to 85° C in a dry environment. The relative humidity should not exceed 80% non-condensing. Always keep the camera as cool as possible. Always allow sufficient time for temperature equalization, if the camera was kept below 0° C!

The camera should be stored in a dry environment with the temperature ranging from -50° to $+90^{\circ}$ C.

CAUTION NOTE

1. Avoid direct exposure to moisture and liquids. The camera housing is not hermetically sealed and any exposure to liquids may damage the camera electronics!
2. Avoid operating in an environment without any air circulation, in close proximity to an intensive heat source, strong magnetic or electric fields.
3. Avoid touching or cleaning the front surface of the optical sensor. If the sensor needs to be cleaned, use soft lint free cloth and an optical cleaning fluid. Do not use methylated alcohol!

1.6.4 Mechanical Drawings

1.6.4.1 C4080 Drawings

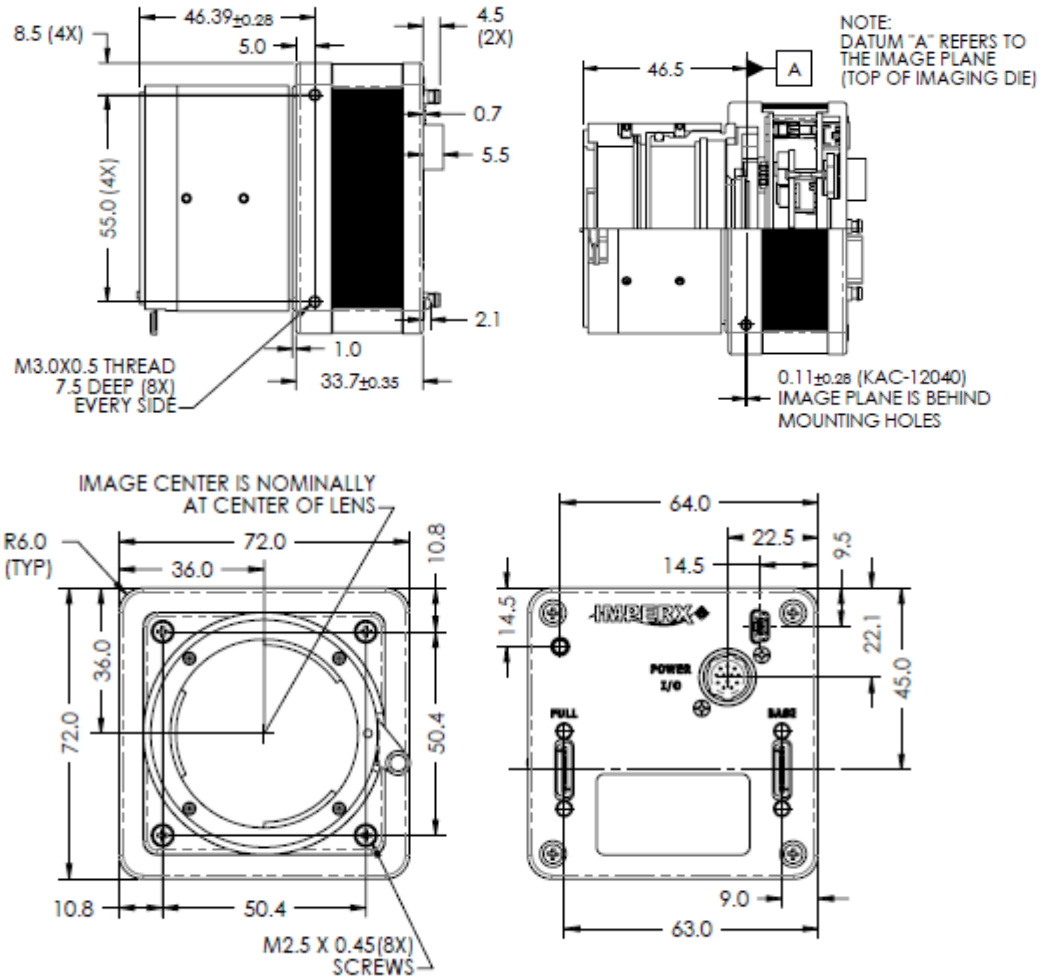

Figures 1.7a: C4080 Mechanical Drawings (F-Mount)

1.6.4.2 C2880 Drawings

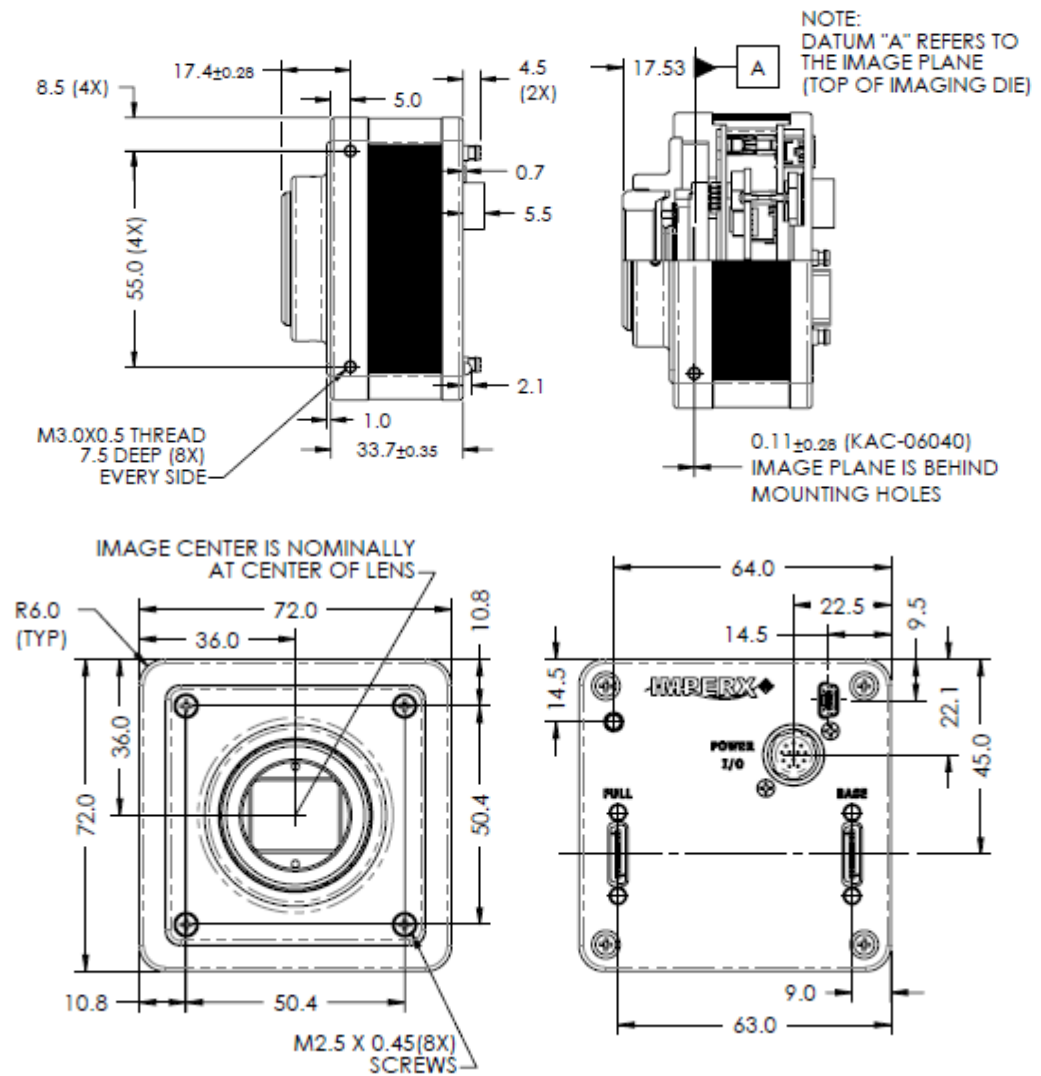

Figure 1.7b: C2880 Mechanical Drawings (C-Mount)

Chapter 2



Camera Features

This chapter discusses the camera's features and their use.

2.1 DUAL VIDEO (FRAME A / FRAME B)

2.1.1 Frame A / Frame B Description

The camera provides two user defined frames (Frame A and Frame B) and the ability to switch seamlessly between the two frames either manually, automatically or triggered. See Section 2.1.2 Frame Switching Options. The user can program each frame with independent control of the following functions:

- Exposure Time
- Frame Period
- Area of Interest (AOI)
- Averaging
- Subsampling
- Gain
- Offset
- Wide Dynamic Range

The dual video function provides the ability to use the image sensors high output frame rate to boost camera functionality. For example, Frame A can be programmed to readout a quad Full HD (QFHD - 3840 x 2160) AOI with 4:1 color averaging so that the resulting camera output is 1080P (1920 x 1080) at video frame rates. Frame B can then be programmed to provide the same Quad Full HD AOI, but without averaging so the resulting camera output is full resolution (QFHD). The user can then switch between Frame A and Frame B (HD and QFHD) resolutions using a variety of different controls and providing a high resolution QFHD video stream and a lower resolution video stream of the same field of view. Figure 2.0 below shows the concept. As another example, Frame B might provide a low resolution contextual image showing the entire field of view at video frame rates while Frame A is programmed to be small AOI within the field of view at full resolution and displayed at much higher frame rates to track objects of interest within the larger scene.

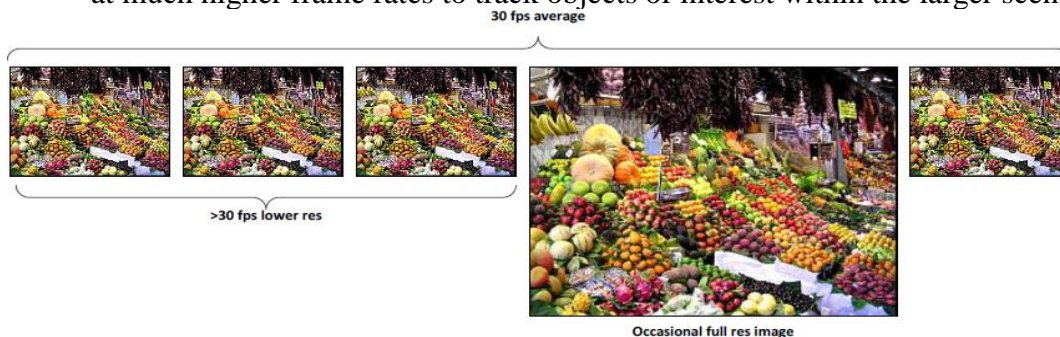

Figure 2.0: Dual Video Operational Example

2.1.2 Dual Video: Frame A / Frame B Switching Options

The cameras provide several options for switching between Frame A and Frame B (Dual Video).

- Manual
- Automatic
- Triggered

Manual switching uses the computer software to switch between Frame A and Frame B.

Automatic switching: The camera outputs a user defined number of frame As ('M' frame As) followed by a user defined number of Frame Bs ('N' Frame Bs) with this sequence repeated continuously. For example, the camera can be programmed to output one Frame B for every sixty (60) Frame A's. The camera can be programmed to provide up to two hundred fifty-six (256) Frame "A's" followed by two hundred fifty-six (256) Frame "B's". The camera continues to output 'M' Frame As followed by 'N' Frame Bs continuously.

Triggered Switching: There are two dual video triggered modes: Dual Video and Dual Video Triggered.

- **Frame A / Frame B**: With trigger enabled and in Frame A or Frame B mode, the camera captures one frame of the selected Frame A or Frame B and outputs it on each trigger.
- **Dual Video**: With the trigger enabled and Dual Video selected, the camera waits for trigger. On receipt of trigger, the camera outputs a user selected number ('M') Frame As followed by a user selected number ('N') Frame Bs then waits for trigger.
- **Dual Video Triggered**: With trigger enabled and Dual Video Triggered mode selected, the camera outputs Frame As continuously until a trigger is received. Upon receipt of trigger, the camera outputs a user defined number ('N') of Frame Bs then returns to outputting Frame As awaiting the next trigger pulse. Valid Trigger sources as described in the Section 2.6: External Trigger.

2.2 GLOBAL/ ROLLING SHUTTER

The camera supports both rolling and global shutter operational modes. In global shutter operational mode, all lines (and all pixels) within the imaging array are reset at the same time and then exposed. Readout follows exposure and lines are readout of the array sequentially. In this mode, every pixel in the array is exposed during the same time period as determined by the cameras exposure control setting. This is useful if an object within the scene is moving, since all pixels within the array capture the image at the same instant in time. Global shutter mode introduces more noise into the image and therefore is not as sensitive as rolling shutter operation. In rolling shutter mode, each line with imaging array is reset and exposed at a slightly different time period. If there is motion within the scene, this can result in distortions to the object in motion, but the size of these distortions will vary based on the readout rate of the camera and the speed of the object in motion. Many applications are not sensitive to these slight distortions. Rolling shutter mode has much more sensitivity as compared to global shutter mode and is useful in light starved applications.

2.3 A/D DIGITIZATION

The user has the ability to select the ADC digitization level within the image sensor to trade-off dynamic range for frame rate. When the user selects 12-bit digitization level, the maximum frame rate is reduced to about 26 frames per second limited by the ADC settling time. When the ADC selector is set to 10-bits, the A/D converter settling time is reduced and the maximum camera output frame rate increases.

2.4 FRAME TIME CONTROL

2.4.1 Internal Line and Frame Time Control

The camera speed (frame rate) depends on the CMOS “read-out” time – the time necessary to read all the pixels out of the CMOS imager. The frame rate can be calculated using the following Formula 1.1:

$$\text{Frame rate [fps]} = 1 / \text{read-out time [sec]} \quad (1.1)$$

The user can program the camera to run slower than the nominal speed preserving the camera full resolution by extending the camera line time (the time required to read one line out of the CMOS imager) and camera frame time (the time required to read the entire frame out of the CMOS imager). Since the image sensor readout speed exceeds the Camera Link interface output rate, the camera automatically sets a minimum line time based on the number of output taps and bit depth selected and

this sets the maximum frame rate consistent with the available bandwidth of the output interface. If the frame grabber is losing data, increase the line time control to match the frame grabber acquisition rate to the Cheetah output rate.

When the Fixed Frame Period control is enabled, the user can increase the frame time from the camera determined minimum frame time to a maximum of 1 sec, with a precision of ~ 1.0us. In this way, the user can reduce the camera output frame rate to match the application requirements.

2.4.2 Camera Output Control

CHEETAH camera supports the following Camera Link Outputs: Single Tap, 2-Tap, 4-Tap, 8-Tap or 10-Tap Output. This corresponds to Base, Medium, Full or Deca Output. These camera settings combined with the output bit-depth (8, 10 or 12-bit) to control the total the interface bandwidth. The output interface clock speed for the Cheetah Camera is 85-MHz (Camera Link Spec is 85 MHz maximum) It is important to match the camera's output to the frame grabber.

Select a frame grabber or camera output based upon the following criteria of data rate:

CLF-C4080

camera	Bit Depth	Output	Data Rate (Gbit/s)	Full Resolution Frame Rate (fps)
C4080	8, 10, 12	Single	1.02	6
C4080	8,10,12	2-Tap (Base)	2.04	13
C4080	8,10,12	4-Tap (Medium)	4.08	27
C4080	8-Bit	8-Tap (Full)	5.44	50
C4080	10-Bit	8-Tap (Full)	6.8	50
C4080	8-Bit	10-Tap (Deca)	6.8	67

Table 2.0: C4080 Frame Rate vs Output Taps

CLF-C2880

camera	Bit Depth	Output	Data Rate (Gbit/s)	Full Resolution Frame Rate (fps)
C2880	8, 10, 12	Single	1.02	13
C2880	8, 10, 12	2-Tap (Base)	2.04	27
C2880	8, 10, 12	4-Tap (Medium)	4.08	50
C2880	8-Bit	8-Tap (Full)	5.44	80
C2880	10-Bit	8-Tap (Deca)	6.8	80
C2880	8-Bit	10-Tap (Deca)	6.8	129

Table 2.1: C2800 Frame Rates vs Output Taps

2.5 AREA OF INTEREST

2.5.1 Overview

For some applications, the user may not need the entire image, but only a portion of it. To accommodate this requirement, CHEETAH provides 1 (one) Region of Interest (ROI) also known as Area of Interest (AOI) for Frame A and one for Frame B. The C4080 offers a pre-programmed quad full HD (QFD) AOI (3840 x 2160 resolution) to simplify camera setup for QFHD applications. The Cheetah also allows custom AOIs as described below.

2.5.2 Horizontal and Vertical Window

The starting and ending point for each AOI can be set independently in horizontal direction (Horizontal Window) and vertical direction (Vertical Window), by setting the window (H & V) offset and (H & V) size – Figure 2.1. The minimum window size is 8 (H) x 2 (V) pixel/line. The maximum horizontal window size (H) and the vertical window size (V) are determined by image full resolution (C4080: 4000 x 3000 and C2880: 2832 x 2128).

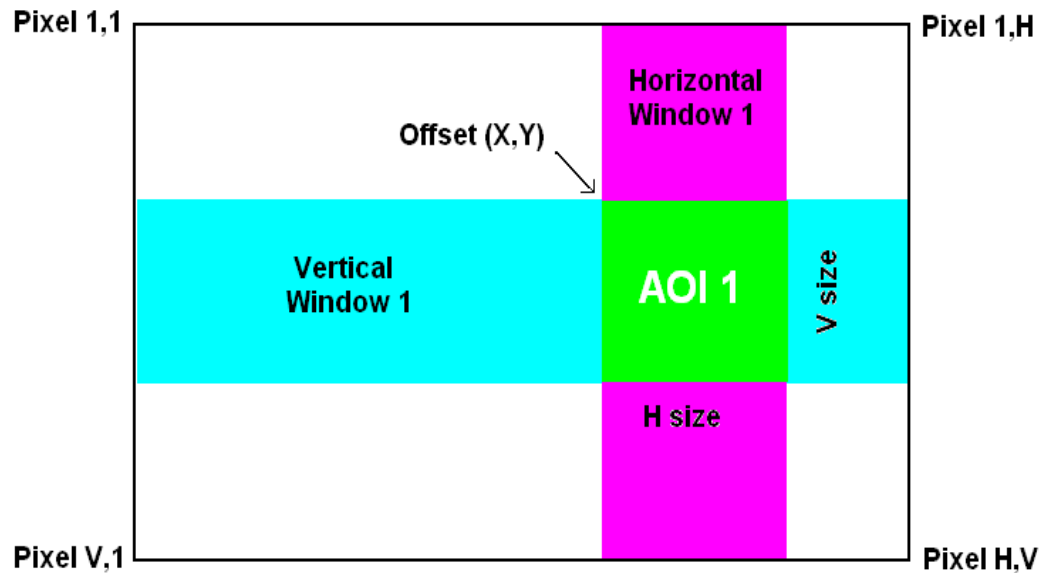

Figure 2.1: Horizontal and vertical window positioning.

Note: Color version users – when AOI is enabled, for proper color reconstruction and WB ‘Offset X’ and ‘Offset Y’ must be an even number.

2.5.3 Factors Impacting Frame Rate

The camera frame rate depends upon a number of variables including the, integration time, number of rows in the AOI, the amount of decimation within the image, the A/D converter bit depth, the bandwidth of the output interface and whether triggered dual video mode is enabled.

AOI size: The camera must readout an entire image sensor row even if the AOI function specifies a lower horizontal (fewer columns) resolution. The camera need not readout all rows, so improvements in frame rate are possible as the number of rows in the AOI decreases.

Exposure Time: The camera overlaps the exposure time and image readout. If the exposure time is increased to a value exceeding the minimum readout time, the frame rate will be reduced accordingly.

Decimation: The camera supports both sub-sampling and pixel averaging to reduce the output resolution. Use of the pixel averaging feature does not increase the image sensor frame rate, because all the pixels must be readout and averaged together.

However, sub-sampling decimation can offer a frame rate improvement by reducing the number of rows readout from the image sensor.

A/D Bit Depth: The image sensor has an A/D converter on each column of the image sensor and reads out two rows simultaneously. There is a finite time required to reach convergence depending upon the A/D digitization level selected and this can impact the maximum frame rate.

- 1) 8-bit digitization: ~9 micro-seconds
- 2) 10-bit digitization: ~9 micro-seconds
- 3) 12-bit digitization: ~20 micro-seconds

For example, if 12-bit digitization is selected, then two rows can be digitized in 20 micro-seconds. Since 3136 rows in the C4080 camera must be readout, digitizing the entire image array consumes 31mS per frame and the frame rate is accordingly limited.

Output Interface Bandwidth: The bandwidth of the output interface can also impact the maximum achievable frame rate. For example, with Camera Link Base (2 taps selected) and with 10-bit digitization and 10-bit output mode selected, the camera will output 13 full-frames per second limited by the output interface bandwidth of 2.04 Gbps.

Triggered Dual Video Mode: The camera normally overlaps the exposure time of one frame with the readout of the previous frame. In Triggered Dual Video Mode, the exposure time and readout time are not overlapped and the total readout time is the sum of the exposure and readout times.

2.5.3.1 AOI Frame Rate Examples

The Tables below describe resulting frame rate (FR) for various AOIs using Camera Link Deca output. The frame grabber speed will impact results and values below assume an x8 speed frame grabber. The camera will calculate and display the actual frame rate at any horizontal and vertical window selection.

Examples of C4080 Frame Rate performance at full resolution and within selected AOIs for 10 and 12-bit digitization are described in Table 2.2.

C4080 Frame Rates (fps)	12-bit CL 4-taps	10-bit, CL 8-taps	8-bit, CL 10-taps
Full Resolution	27	50	67
3840 x 2160	40	82	90
1920 x 1080	80	172	172
1280 x 720	110	243	243

Table 2.2: C4080 AOI frame rate for various AOIs

Examples of C2880 frame rate performance at full resolution and within selected AOIs for 8, 10 and 12-bit digitization are described in Table 2.3.

C2880 Frame Rates (fps)	12-bit, CL 4-tap	10-bit, CL 8-tap	8-bit, CL 10-tap
Full Resolution	50	80	129
1920 x 1080	143	241	241
1280 x 720	202	342	342
640 x 480	275	473	473

Table 2.3: C2880 Maximum Frame Rate for various AOIs

2.6 SUBSAMPLING

2.6.1 Pixel Averaging

The principal objective of the averaging function is to reduce the image resolution with better final image quality than a sub-sampling function. Sub-sampling as opposed to averaging has the advantage of increasing the output frame rate by reducing the number of rows readout, but also introduces aliasing in the final image. Pixel averaging reduces the output resolution by averaging several pixels together and has the advantage of reducing aliasing **and** reducing noise which increases SNR. Averaging decimation, however, does not increase output frame rate.

It is possible to apply both averaging and sub-sampling decimation simultaneously to gain both improvements in frame rate and improvements in SNR while minimizing aliasing. The camera offers a 4:1 (read as “four into one”) and a 9:1 (nine into one) averaging function, compatible with both monochrome and color (Bayer) cameras. Averaging four pixels together reduces the temporal noise and increasing sensitivity by a factor of 2, while averaging 9 pixels together reduces the noise by a factor of 3.

The graphic below illustrates the concept of 4:1 averaging for a monochrome image sensor. The values of pixels P1, P2, P3 and P4 are summed together arithmetically and the result is divided by 4 to achieve a pure arithmetic average of the 4 adjacent pixels.

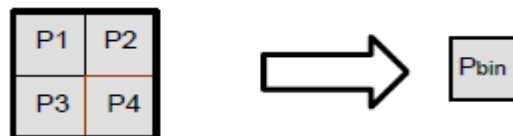

Figure 2.2: Monochrome pixel averaging

Color pixel averaging works in a similar manner, but like color pixels are aggregated to maintain the Bayer pattern and to allow the standard Bayer interpolation color processing algorithms to be used. 4:1 color pixel averaging is described in Figure 2.3 below. As shown, red pixels (R1, R2, R3 and R4) are aggregated together and the result is divided by 4 to create an average red pixel value. Likewise, Green (GR1, GR2, GR3 and GR4) are summed together and the result divided by 4 to generate the green pixel in the red-green pixel row. Green pixels in the blue-green row are similarly processed along with the Blue pixels. The result of these operations is to preserve the Bayer pattern while averaging like color pixels to reduce the output resolution while increasing SNR.

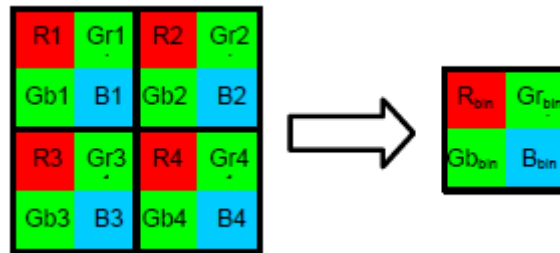

Figure 2.3: Principle of 4:1 averaging for Bayer Color Filter Pattern

The principle of 9:1 averaging function is identical to 4:1 with a 3x3 pixel area averaged together for B&W and a 9x9 pixel area averaged for the Bayer color pattern.

The averaging feature can be used on the full resolution image or within any area of interest. If, for example, the area of interest is defined to be quad full HD (3840 x 2160) and 4:1 averaging is selected, the output is 1080P (1920 x 1080); and, if 9:1 averaging is selected the output is 720P (1280 x 720)

2.6.2 Sub-sampling Decimation

Subsampling reduces the number of pixels output by reducing the output frame size, but maintains the full field of view. If an area of interest (AOI) is selected, then the field of view of the AOI is maintained.

The Cheetah cameras provide a very flexible subsampling capability. The user defines how many sequential pixels to read out (N) and how many total pixels of the contiguous area (pixels readout + pixels skipped) (M). The sub-sampling decimation factors (N and M) are applied along both rows and columns as shown in the figures 2.4a and 2.4b. The camera will adjust AOI size depending on subsampling factor, averaging factor and the presence of a color filter array on the image sensor.

Subsampling constraints

- The N (# contiguous pixels readout) and M (# pixels of the area which includes pixels readout and pixels skipped) parameters are restricted to even values
- M must always be greater than N and maximum value of M is 32.

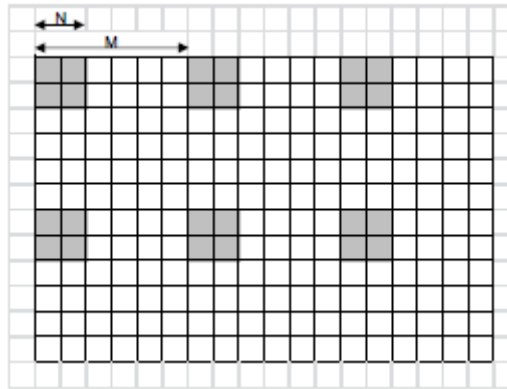

Figure 2.4a: Monochrome sub-sampling example with N = 2 and M = 6.

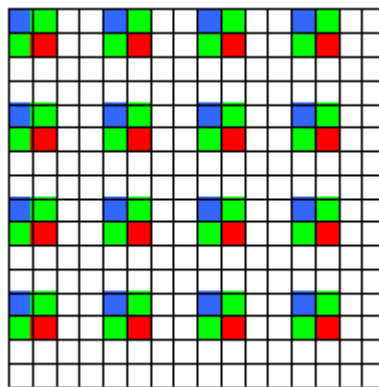

Figure 2.4b: Color sub-sampling with N=2 and M=4.

2.7 EXPOSURE CONTROL

2.7.1 Internal Exposure Control - Electronic Shutter

In rolling shutter mode, each row is reset (cleared of signal) sequentially (one after another). The delay between the time that a row is reset and the time when this row is readout is the exposure time. While rolling shutter mode offers superior noise performance (and thus better sensitivity) as compared to global shutter mode, in rolling shutter mode each row of the image is captured at a slightly different time and this can introduce image artifacts when the camera or the object is moving.

In global shutter mode, all pixels in the array are reset at the same time, allowed to collect signal during the exposure time and then readout sequentially. In this way, all pixels capture the image during the same time period reducing any image artifacts due to motion within the scene or the camera.

In free-running mode for both global and rolling shutter modes, the exposure time overlaps the camera readout and is positioned to occur at the end of the frame readout. The internal exposure control timer controls the exposure and is organized into two counters: a line counter and a partial-line (sub-line) counter. In free-running mode, frames are readout one after another so the maximum exposure time is equal to the frame time. With no frame period control (Fixed Frame Period disabled), there are 1146 lines per frame. Increasing the frame period using the Fixed Frame Period control, adds additional lines (vertical blanking) to the frame readout increasing the frame period and also increasing the maximum exposure time.

The exposure time can be computed by first converting the contents of the Integration Lines counter and Integration Clocks (partial line) counter to time using the following Frame A exposure time equation. (Frame B is the same, save the register addresses have different values)

- 1) Exposure Time = (Integration Lines Counter [e.g., Reg 0728] x Line Time [e.g., Reg 0710]) + (Integration Clocks (Partial Line) Counter [e.g., Reg 072C] x 6.25 nS) [Note: all register values must be converted from hex to decimal]
- 2) Line Time:
The line time can be computed in one of two ways:
 - A) Reading the contents of Line Time register (Reg: 0710 for Frame A or Reg 0714 for Frame B), converting the hex number to decimal and multiplying by 6.25nS
 - B) Measuring the frame time (GUI monitor screen) in free running mode with the fixed frame period disabled and dividing by 1146 lines per frame.

The minimum exposure in global shutter mode is 5 microseconds and 1 microsecond in rolling shutter mode.

As mentioned above, the exposure time cannot exceed the frame time. To increase the exposure time, first increase the frame period to the maximum desired exposure time and then adjust the exposure time.

In free-running (non-triggered) operation, the camera overlaps the exposure and readout times for both global and rolling shutter modes as shown in Figure 2.5a and Figure 2.5b. Both figures show an 8.33mS exposure time overlapping with the 13.8 ms readout time. Figure 2.5c shows non-overlap exposure and readout in using an Trigger.

Rolling Shutter

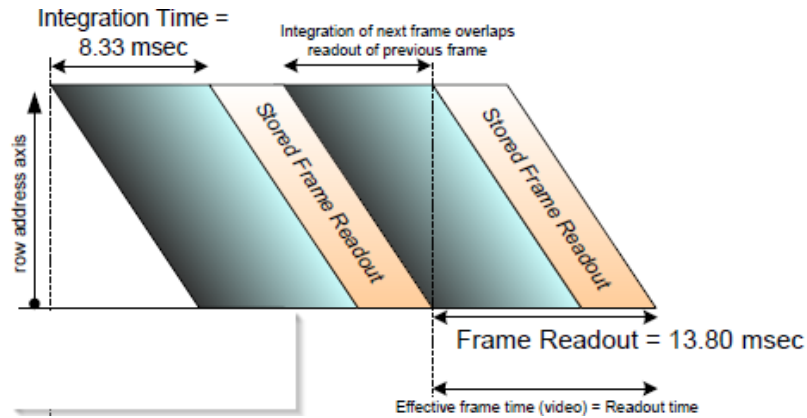

Figure 2.5a: Rolling Shutter Mode with 8.33 ms exposure time.

Global Shutter

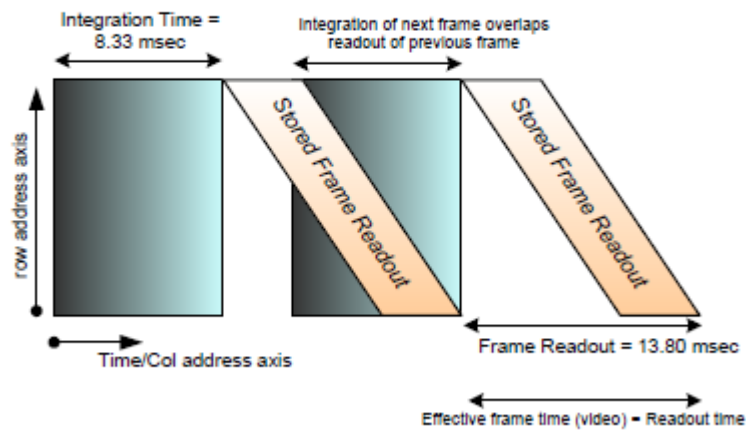

Figure 2.5b: Global Shutter with 8.33mS exposure time

With external trigger, exposure times and readout times do not overlap and the effective frame time is the sum of both values.

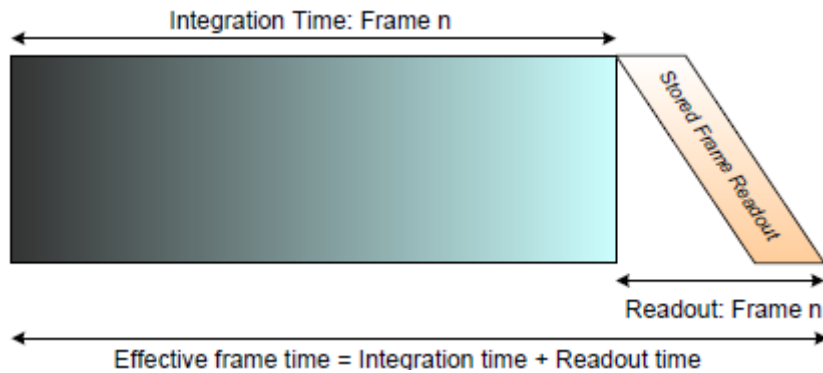

Figure 2.5c: Global Shutter Mode with a long exposure period (integration time)

2.7.3 External exposure control

When using the external trigger (whether with the internal exposure timer or with trigger pulse width), the exposure and readout are not overlapped.

When using the internal exposure timer and external trigger, the following sequence occurs:

- A) The camera waits for the trigger signal.
- B) Upon trigger, there is a delay of ~45 micro-seconds plus 1 to 2 line times
- C) Then the exposure period begins followed by readout.
- D) The camera then idles and awaits the next trigger.

The camera exposure can be controlled using an external pulse and the pulse duration determines the exposure. In global shutter mode, the minimum exposure time is about 6 micro-seconds. In rolling shutter mode, the minimum exposure time is equal to the frame time, because the exposure must occur during the readout time. Please refer to 2.8 Camera Triggering and 2.14 I/O control sections.

2.7.4 Variable Frame Time – Programmable Line and Frame Time

Variable frame time control provides the ability to run the camera in full resolution and a frame rate slower than the nominal frame readout rate. The camera can provide very high data rates that can quickly over-run the bandwidth of the frame grabber and output interface. By adding a delay after the readout of each line and at the end of the frame, the overall output frame rate can be reduced matching the camera frame rate to each application-specific requirement. Use the programmable line time to add delay at the end of each line readout to match the camera data output rate so the frame grabber does not experience over-runs. Use the programmable frame period to add additional line delays at the end of the frame to achieve the desired frame time. The line time control should only add enough delay to the camera line

time to match the frame grabber data capture rate. Adding additional line delay will decrease overall camera performance by increasing dark current within the image.

CAUTION NOTE

1. If the frame time is greater than 50ms the camera has to be kept still otherwise a motion smear will appear on the image.

2.8 CAMERA TRIGGERING

2.8.1 Triggering Inputs

In the normal mode of operation, the camera is free running. Using the trigger mode allows the camera to be synchronized to an external timing pulse. Trigger inputs can be used to control the exposure times of Frame A and Frame B or can be used to control Dual Video mode switching. In Dual Video mode, enabling the trigger input causes the camera to output a user defined number of Frame As followed by a user defined number of Frame Bs upon receipt of Trigger. In Dual Video Trigger mode, the camera outputs Frame As until trigger is received and then outputs a user defined number of Frame Bs.

There are three input modes available for external triggering – computer (CC), internal (pulse generator), and external. Please note that the desired trigger input has to be mapped to corresponding camera input. For more information, please refer to Section 2.14: I/O Control.

- **“External”** – the camera receives the trigger signal coming from the connector located on the back of the camera.
- **“Computer”** – the camera receives the trigger signal command from the CC signals.
- **“Internal”** – the camera has a built in programmable pulse generator – refer to “Pulse Generator” section. In Internal triggering mode, the camera receives the trigger signal from the internal pulse generator.

2.8.2 Acquisition and Exposure Control

For each trigger input the user can set the trigger edge, and the de-bounce (de-glitch) time/

1. **“Triggering Edge”** – the user can select the active triggering edge:
 - **“Rising”** – the rising edge will be used for triggering

- “**Falling**” – the falling edge will be used for triggering
- 2. “**De-bounce**” – the trigger inputs are de-bounced to prevent multiple triggering from ringing triggering pulses. The user has eight choices of de-bounce interval:
 - “**Off**” – no de-bounce (default)
 - “**10**” μ s, “**50**” μ s, “**100**” μ s, “**500**” μ s de-bounce interval
 - “**1.0**” ms, “**5.0**” ms, “**10.0**” ms de-bounce interval
 - .
- 3. “**Exposure Time**” – the exposure for all frames can be set in two ways:
 - “**Pulse Width**” – the trigger pulse width (duration) determines the exposure subject to limitations. In GS mode, the minimum exposure is about 6 micro-seconds. In RS mode, the minimum exposure is equal to the minimum frame time.
 - “**Internal**” – the camera internal exposure register determines the exposure.

CAUTION NOTE

1. The de-bounce interval **MUST** be smaller than the trigger pulse duration. Adjust the interval accordingly.
2. When Triggering is enabled “Programmable Integration” is not active

2.8.3 Triggering modes

A. Exposure Control

When Trigger mode is enabled, the trigger can be used to control the integration time of Frame A and / or Frame B using the Exposure Control Trigger Pulse Width control. The trigger can also be used to switch between Frame A to Frame B in dual video Trigger mode. The Exposure Control Trigger Pulse Width option is only available when single video (either Frame A or Frame B) is selected. **Control of the exposure using the trigger pulse width is not available in Dual Video or Dual Video Trigger modes.**

GS Mode: When the trigger pulse width is used to control the exposure time in GS mode, the camera idles and waits for a trigger signal. Upon receiving the trigger signal, the camera starts integration for the frame, completes the integration and the image is readout. There is small delay between the trigger active edge and the exposure start as shown in the figure below. The exposure time can be set manually using the internal exposure register setting as shown in Figure 2.6a or set by the duration of the trigger pulse as shown in Figure 2.6b. The minimum exposure time using the trigger pulse width is 2 micro-seconds. Upon completing the readout, the trigger cycle is completed and the camera idles awaiting the next trigger pulse.

RS Mode: With limitations, the exposure time can be controlled using trigger pulse width. In this case, the minimum exposure time is equal to the time required to reset all the rows within the image sensor (the time readout one frame of the image sensor). In other words, the minimum exposure time is equal to the frame time. Longer exposure times are possible, but exposures shorter than one frame time are not supported.

Upon receiving the active edge of the trigger signal, the camera resets image sensor row #1 and exposure of line #1 begins. One row time later, row #2 is reset and the integration of row #2 begins. Each row is reset one-line time after the prior row and this process continues until the entire image sensor is reset. When the trigger signal goes inactive (must be one frame time min. later), the integration concludes for the first row and the image sensor is readout one line at a time. The time between trigger pulses (start of exposure) must be at least the exposure time plus the readout time of the image sensor.

It is possible to use strobed illumination in rolling shutter mode, if the scene is completely dark. In RS mode, the flash must occur after all the rows within the image sensor have been reset (one frame readout time) and the exposure time must therefore be set to the sum of the image sensor readout time plus the exposure window for the flash. The sequence is as follows: the exposure starts and all rows in the image sensor are reset (one frame time), the strobe illumination flashes, the exposure ends and the readout begins. Once the readout has completed, the next exposure can begin.

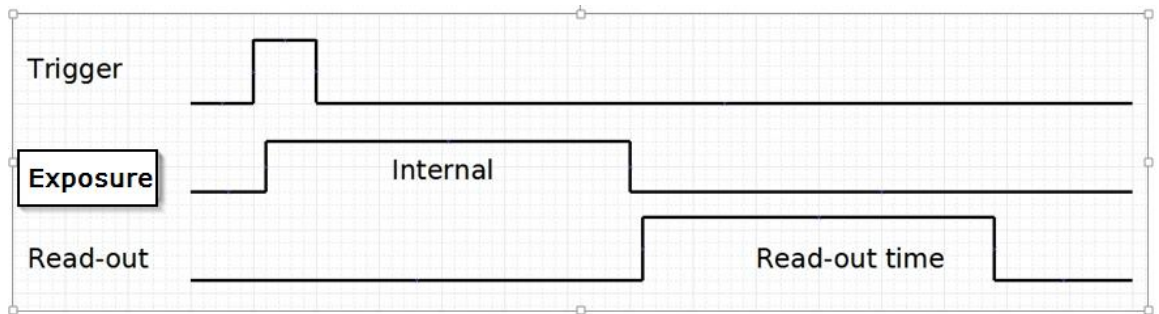

Figure 2.6a: Standard Trigger Mode (Internal Exposure Control)

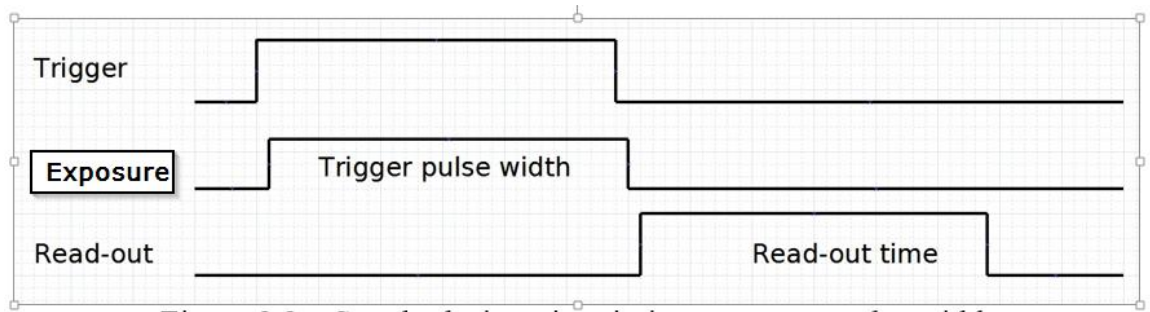

Figure 2.6b: Standard Trigger Mode (GS Trigger Pulse Width Exposure Control)

B. Dual Video Trigger

If the Dual Video Trigger Option is selected, the camera outputs Frame 'A' continuously until the external trigger signal is received. Upon receipt of the external trigger, the camera switches to Frame B and outputs 'N' Frame Bs where is user selectable from $N = 1$ to 256. After outputting 'N' Frame Bs, the camera reverts to Frame A and outputs Frame A's until receipt of the next trigger input.

CAUTION: The time interval between trigger pulses must be greater than the combined exposure and frame time. If the time between triggers is too short, then the camera will ignore some trigger pulses

2.9 STROBES

The camera can provide up to two strobe pulses for synchronization with an external light source, additional cameras or other peripheral devices. The user can set each strobes pulse duration and the delay with respect to the start of the exposure period or the start of the readout period for either Frame A, Frame B or both. The maximum pulse duration and the maximum delay can be set up to 1 second with 1.0us precision. The strobe pulse can be assigned to either external output. Figure 2.7 shows two strobe signals positioned with respect to the start of exposure. See Section 2.14 I/O Control.

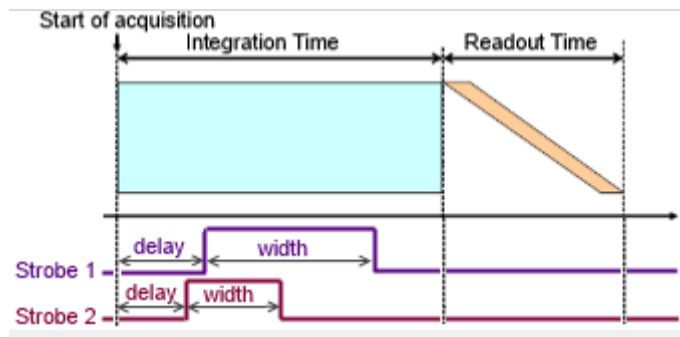

Figure 2.7: Strobe positioning with respect to exposure start

2.10 VIDEO AMPLIFIER GAIN AND OFFSET

2.10.1 Analog Domain – manual control

The camera takes advantage of the analog gain functionality built into the KAC-12040 image sensor. The manufacturer recommends applying analog gain before using the digital gain function. The image sensor automatically adjusts the black level as the analog gain is adjusted to minimize fluctuation. The user adjustable target black level is added after the gain stage and adjustments to this setting will not impact dark level sensitivity. The gain range depends upon output bit depth with gains of 1x, 2x and 4x (12dB) gain possible using 12-bit digitization and 1x, 2x, 4x and 8x (18dB) possible using 10-bit digitization.

For 10-bit digitization, there are 15 different potential gain settings while 12-bit digitization has 7 potential settings as described formula and table below:

10 Bit Digitization Gains:

$$\text{Analog Gain} = 16 / [(\text{Select Code Bits (5:0)}) / 2];$$

12-Bit Digitization:

$$\text{Analog Gain} = 4 / [(\text{Select Code Bits (4:0)}) / 2]$$

Note: Bit 0 is always 0 and Select code =2 and gains less than 1 are not allowed.

Analog Gain Vs Select Code		
Select Code	10-Bit Gain	12-Bit Gain
2	NA	4.00
4	8.00	2.00
6	5.33	1.33
8	4.00	1.00
16	2.00	NA
32	1.00	NA

Table 2.4: Analog Gain Steps

2.10.2 Digital Domain – manual control

As mentioned under Analog Domain – manual control, for optimal noise performance, analog gain should be applied before digital gain. Digital gain is applied before the application of the user selected target black level. To provide finer control at lower gain settings, the digital gain step size varies according to Table 2.5 below.

Gain range	Step
1 to 1.984375	0.015625
2 to 3.96875	0.03125
4 to 7.9375	0.0625
8 to 15.875	0.125

Table 2.5: Digital Gain Range and Step Size

2.11 WIDE DYNAMIC RANGE (WDR)

2.11.1 Overview

The Cheetah cameras introduce an exciting new feature for outdoor and uncontrolled lighting applications. The extended dynamic range function (or wide dynamic range function) is applied to each individual pixel. In WDR mode, the camera effectively

varies the exposure time of each individual pixel based on the intensity of the source at each pixel location. For each pixel, the camera can be programmed to select from up to four user defined exposure periods based on the intensity of the source at the individual pixel. For example, the user can set an ultra-short exposure for ultra-bright pixels within the image, a longer exposure for very bright pixels, a long exposure for bright pixels while dark pixels within the image are allowed to integrate for the full exposure period. The camera determines the intensity of the source at each pixel and categorizes the pixel into “dark”, “bright”, “very bright” or “ultra-bright” based on user defined criteria. The user need not know which pixels are bright or dark, the camera takes care of managing these details. Unlike some extended dynamic range schemes which involve two or more separate exposures separated by one or more frame times, Cheetah can provide as many as four separate exposures based on the source intensity at each pixel within one exposure time eliminating motion artifacts. While up to four separate exposures are possible, the user can opt to use only two or three separate exposures for simplicity. The user defines the exposure periods and also partitions the camera output to collect the data for the dark, bright, very bright and ultra-bright pixel information. In this way, up to four different intensity slopes can be captured in one image capture.

Figures 2.8a and 2.8b demonstrate the WDR functionality

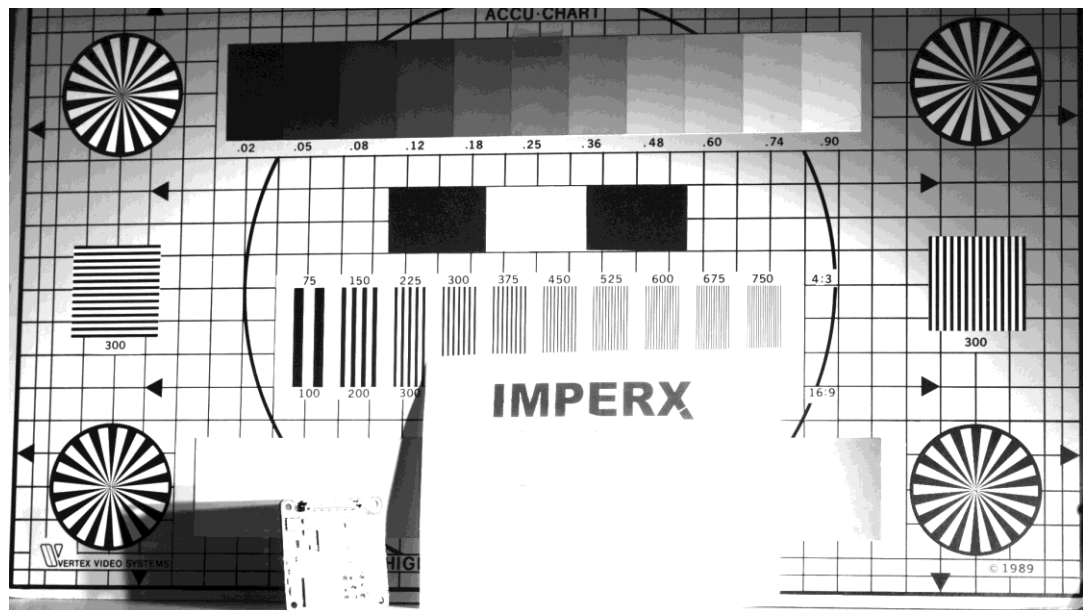

Figure 2.8a: WDR mode disabled

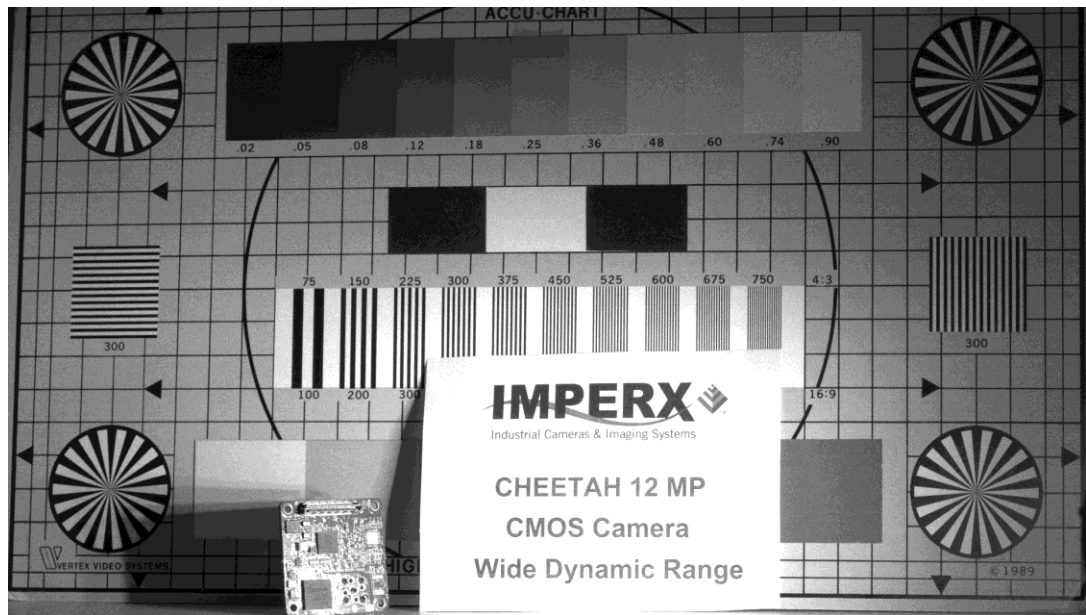

Figure 2.8b: WDR mode enabled

To extend the dynamic range of the camera, the output is partitioned into several user defined zones. In the simplest case, the user partitions the output into one region for dark pixel data in which pixels integrate for the full exposure period and another region for bright pixel data in which pixels integrate for only a small portion of the total exposure period. Table 2.6a demonstrates one such partitioning. Assuming 10-bit digitization, Dark pixel data have values from 0 to 512 counts (50% of the output) and Bright pixel data values range from 513 to 1024 counts (51% to 100% of the output). The user must keep in mind, however, that Bright pixel data was captured with a much shorter exposure period. For example, suppose the user selects a Bright pixel exposure period which is 10% of the overall exposure period. In this case, a pixel with a value of 612 counts resides in the Bright pixel data partition and represents 100 counts (612 – 512) taken with an exposure that is 10% of the total exposure. These 100 counts of signal then were collected with 1/10th the exposure time of the Dark pixels and therefore these 100 counts are 10x brighter than 100 counts of signal collected in the Dark pixel partition.

Percentage of Output	Pixel Data
100%	Bright Pixel Data
51%	
50%	Dark Pixel Data
0%	

Table 2.6a: Example of possible output partitioning for 2 intensity slopes

Table 2.6b is just one example of how the output can be partitioned into four separate exposure zones. To reinforce the concept of output partitioning, let's suppose that the user selects the partitioning in Table 2.6b with 10-bit digitization and selects the total exposure to be 50ms (Dark pixels), the Bright pixel exposure to be 5ms, the Very Bright pixel exposure to be 0.5ms and the Ultra-Bright pixel exposure to be 0.05ms. In this example (See Table 2.6b), Dark pixels with a 50ms exposure are contained between 0 to 300 output counts (30% of output), Bright pixel data with a 5ms exposure have counts between 301 to 600, Very Bright pixel data with 0.5ms exposures have counts between 601 to 800 and Ultra-Bright pixel data with 0.05ms exposures have counts between 800 to 1000. A single count in the Ultra-Bright pixel data region represents signal that is 1,000x higher intensity (50ms / 0.05ms) than a single count in the Dark pixel data region.

Percentage of Output	Pixel Data
100% 81%	Ultra-Bright Pixel data
80% 61%	Very Bright Pixel Data
60% 31%	Bright Pixel Data
30% 0%	Dark Pixel Data

Table 2.6b: Example of output data partitioning for 4 intensity slopes

As another example of the range of exposures possible, the user can set the exposure period for the pixels in the darkest region of the image to be say, 33.0 milliseconds, consistent with a 30 frame per second video rate. For Bright pixels within the scene, an exposure time of 3 milliseconds can be selected and for Very Bright pixels, an exposure time of 300 micro-seconds might be selected. The output would then be partitioned into three zones: one for Dark pixel exposure data, another for Bright pixel exposure data and another section for Very Bright pixel data.

It is useful to set the wide dynamic range parameters using ratios. The overall entire exposure period (T_{exp}) is the time during which the dark pixels integrate to some value. As an example, let's describe this time period as the quantity "X" and the user has specified that 40% of the output range is allocated to Dark pixel data. The user might then set the exposure time for Bright pixels to 5% of the overall exposure period (Bright pixel exposure is $0.05X$) and allocate 35% of the remaining output to these bright pixels. Finally, for the Very-Bright pixels within the scene, the user might set the exposure time to 0.5% of the overall exposure. (Very-bright pixel exposure is $0.0025X$). The remaining portion of the camera output (25%) is allocated to these Very -Bright pixels. In this way, the camera can support three separate exposure periods.

Figure 2.9 compares a single slope (normal CCD or CMOS camera) exposure with a dual slope exposure in which Dark pixels integrate for the full exposure period up to 30% of the camera output while Bright pixels integrate for only 10% of the exposure period with 70% of the camera output partitioned to Bright pixel information.

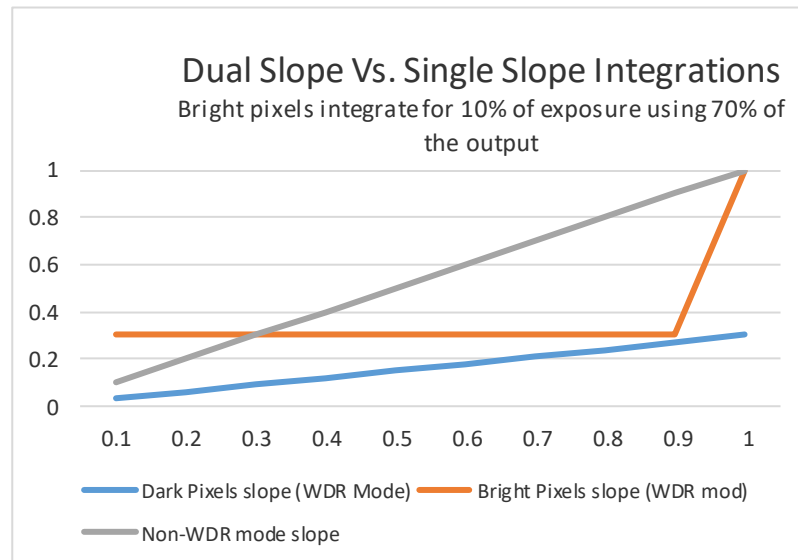

Figure 2.9: Dual Slope vs Single Slope Integration

The user can translate pixel data back to linear space by accounting for the different exposure periods in each of the output partitions. For example, suppose Bright pixel data is contained between 301 and 1000 of the camera output counts (10-bit system). By subtracting, 300 from every pixel with a value greater than 300 counts and multiplying the result by the ratio of the Total Exposure (Texp) period divided by the Bright pixel exposure period, the Bright pixel data can be properly referenced to the Dark pixel data.

$$\text{Bright pixel (Linear)} = (\text{Bright pixel counts} - \text{Dark pixel max counts}) \times (\text{Texp} / \text{Bright pixel exposure period})$$

Another way to view the data partitioning concept is to use view the histogram of the output data. In Figure 2.10, a histogram is shown with four output partitions. Again, the user must bear in mind that each data region (Dark, Bright, Very Bright and Ultra-Bright) has a different exposure time.

Wide Dynamic Range (WDR) - Histogram View

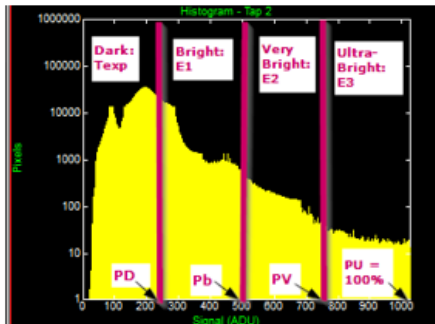

Percentage (of output) Dark (PD) set to 25% (P1 in GUI)
 Percentage (of output) Bright (Pb) set to 50% (P2 in GUI)
 Percentage (of output) Very Bright (Pv) set to 75% (P3 in GUI)
 Percentage (of output) Ultra-bright (PU) set to 100%

- Dark Pixel Data:
 - exposure time = T_{exp}
 - between 0 counts and PD
- Bright Pixel Data:
 - Exposure time = T_b ($T_{exp} - E1$ in GUI)
 - Between PD and P_b (250 to 500)
- Very Bright Pixel Data
 - Exposure time = T_v ($T_{exp} - E2$ in GUI)
 - Between P_b and P_v (500 to 750)
- Ultra-Bright Pixel Data
 - Exposure time = T_u ($T_{exp} - E3$ in GUI)
 - Between P_v and P_u (750 to 1000)

Figure 2.10: Output partitioning using Histogram

2.11.2 Wide Dynamic Range Controls

Extended Dynamic Range feature is only available in global shutter mode. The user has the option of enabling or disabling extended dynamic range. When disabled, all pixels within the array integrate charge for the full exposure period as defined by the exposure control settings. When wide dynamic range is activated, the exposure period for each pixel varies based on the following user defined settings:

‘Dark’ Pixels: Exposure period is set by the normal camera exposure controls and dark pixels integrate for the full exposure period (T_{exp}), just as if the WDR mode were disabled. The amount of the camera output allocated to dark pixels is set by parameter P1 and dark pixel data is contained between 0% of camera output to the P1 percentage level. P1 can range from 15% of the camera output to 100% as shown in Table 2.6c. If P1 is set to 100%, then the entire output is allocated to Dark Pixels and WDR is effectively disabled.

100
90
80
75
70
65
60
55
50
45
40
35
30
25
20
15

Table 2.6c: Camera output allocation (%)

‘Bright’ Pixels: The exposure period for ‘bright’ pixels is set by parameter E1. The Bright pixel exposure period is defined as the Total Exposure Period (Texp) minus E1. For example, if Texp (Dark Pixel Exposure time) is 50ms and it is desired to set the Bright pixel exposure period to 5ms, then E1 must be set to 45ms. (50ms – 45ms = 5ms).

$$T_b (\text{Bright}) = \text{Texp} - E1;$$

E1 is a value in microseconds and must be some fraction of the overall exposure period (usually 90% of Texp or more). The minimum value for E1 is 2 microseconds. Bright pixel data is partitioned between the P1 and P2 output settings. Like P1, parameter P2 which can have values ranging from 15% to 100% of the camera output (16 steps) and **must be** greater than P1. See Table 2.6c. If P2 is set to 100%, then the camera output is partitioned into two zones: Dark Pixel data (0% to P1) and Bright pixel data (P1 to 100%)

‘Very Bright’ Pixels: The exposure period for the Very Bright pixels is set by parameter E2. The Very Bright pixel exposure period is defined as the Total Exposure Period (Texp) minus E2. For example, if Texp (Dark Pixel Exposure time) is 50.0ms and it is desired to set the Very Bright pixel exposure period to 0.5ms, then E2 must be set to 49.5ms. (50.0ms – 49.5ms = 0.5ms)

$$T_{vb} (\text{Very Bright}) = \text{Texp} - E2;$$

E2 is a value in microseconds and must have a value between the E1 exposure period and Texp. The minimum E2 value is 2 micro-seconds. The amount of camera output allocated to Very Bright pixels is set by parameter P3 which can have values ranging from 15% to 100% of the camera output (16 steps) and must be greater than P2. The Very Bright’ pixel data is contained between the P2 percentage of output and the P3 percentage of output. See Table 2.6c. If P3 is set to 100%, then the camera output is partitioned into three zones.

‘Ultra-Bright’ Pixels: The exposure period for ultra-bright pixels is set by parameter E3. The Ultra- Bright pixel exposure period is defined as the Total Exposure Period (Texp) minus E3. For example, if Texp (Dark Pixel Exposure time) is 50.00ms and it is desired to set the Ultra-Bright Pixel exposure period to 0.05ms, then E3 must be set to 49.95ms. (50.00ms – 49.95ms = 0.05ms).

$$\text{Tub (Ultra-Bright)} = \text{Texp} - \text{E3};$$

E3 is a value in microseconds and must have a value larger than E2, but less than Texp. The minimum E3 value is 2 micro-seconds. The amount of camera output allocated to Ultra- Bright pixels is between the P3 setting and 100% of the camera output.

Figures 2.11a-d is a single knee point demonstration of the WDR function. It is useful to note how the output histogram changes as P1 is varied from 75% to 50% to 25%.

Wide Dynamic Range (WDR) Using the Histogram (1 knee point)

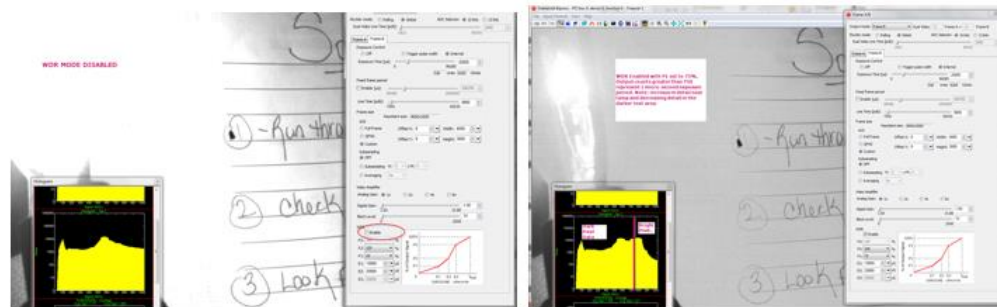

WDR Disabled. The output represents the ‘normal’ Dynamic Range. All output counts were exposed for full 20mS exposure time.

PD (P1) Set to 75%, Counts greater than 750 received a 1 micro-second exposure, Counts below 750 received full 20mS exposure.

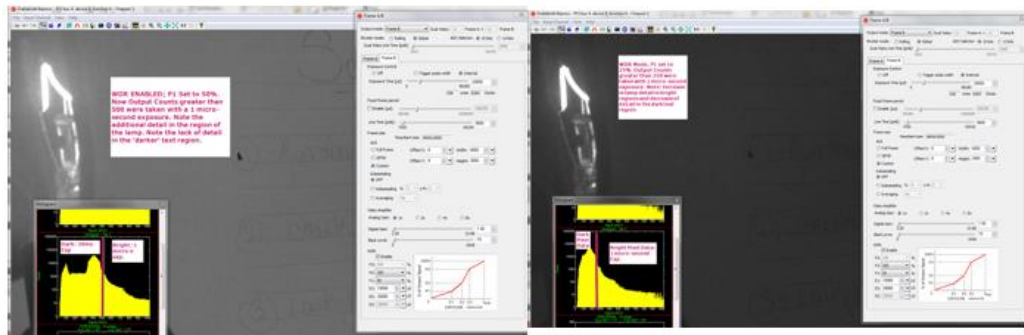

Pd (P1 in GUI) is set to 50%; Output counts greater than 500 were exposed for 1 micro-second.
Note: more detail in lamp region and less contrast in dark.

Pd (P1) is set to 25%, Output counts greater than 250 were exposed for 1 micro-second.

Figures 2.11a-d: a single knee point demonstration of the WDR function.

2.11.3 Initial WDR Setup Recommendations

For initial extended dynamic range set up, the setup below provides one knee point and quickly gets a usable image and allows experimentation with various settings.

- 1) Set the overall exposure period so the dark portions of the image are visible with good contrast while other portions of the image are over-exposed with no visible detail.
- 2) Set E1 to 90% (or 95%) of the overall exposure period.
- 3) Set P1 to 50% then P2 and P3 to 100%.
- 4) Try varying P1 and E1 and observe the impact on the image (and histogram)

Increasing P1 will increase the amount of contrast in the dark regions of the image while decreasing contrast in the bright regions. If the dark regions appear noisy or if the color reproduction in the dark regions is poor, try increasing P1. Changing E1 changes the exposure period for the bright areas of the image. If more contrast is needed in these brighter regions of the image, try increasing P1. View a histogram of the output to get a sense of how changes in P1 affect the output.

In a scene with several different intensity levels, two knee points can be helpful. If two knee points (3 intensity slopes) are required, then both E1 and E2 (E1 is the exposure period for bright pixels and E2 is the exposure period for the Very Bright pixels.) must be used. Below is an initial setting for applications that have several areas of varying intensities.

- 1) Set the overall camera exposure period so areas in the darkest regions of the image have contrast and the bright areas of the image are overexposed.
- 2) Set Texp - E1 to 10% of the overall exposure period and Set Texp - E2 to 1% of the overall exposure period

- 3) Set P1 to 40%, P2 to 70% and P3 to 100%.

Extended dynamic range images will look 'flat' and 'dark', because the bright areas of the image have been compressed into the camera's output range. Viewing the histogram of the output is a very useful tool for seeing the impact of changes to P1, P2 and P3 settings. The LUT function can be used to stretch the image and increase the image 'brightness', if needed, keeping in mind that data is not linear and is partitioned into different exposure ranges.

2.11.4 WDR at maximum frame rates (image artifact prevention)

To provide the highest frame rates, the exposure time and readout time overlap—meaning while Frame 1 is being readout out, Frame 2 is being exposed. The exposure period for Frame 2 is always positioned at the end of the Frame 1 and any additional WDR exposures (E1, E2 and E3) are positioned at the very end of the overall exposure time.

When the application demands maximum frame rate, then the exposure period of Frame 2 overlaps with the readout of Frame 1. (For lower frame rate applications, the exposure for Frame 2 will occur after Frame 1 is readout (non-overlapping)). An image artifact (a faint horizontal line) may be seen at the beginning of the WDR (E1, E2 and E3) exposures, **if** the WDR exposures for Frame 2 overlap with the Frame 1 readout time. At maximum frame rate, these artifacts typically occur very near the bottom of the image.

For example, suppose the camera is providing a system constrained maximum frame rate of 50 fps (20,000 micro-second frame time). Let's also suppose that the exposure time (Texp) is set to 5,000 micro-seconds and two additional WDR exposures (E1 and E2) are used. E1 is set to 4,000 micro-seconds (a WDR exposure of 1,000 micro-seconds) and E2 is set to 4,900 micro-seconds (a 2nd WDR exposure of 100 micro-seconds). Let's also assume a full 4000 x 3000 resolution image is readout from the C4080 camera and Frame 1 begins reading out at time equals 0 seconds. In this example, the exposure for Frame 2 begins 15,000 micro-seconds after the Frame 1 readout begins (5,000 microseconds before the end of the Frame 1 readout time) and the first WDR exposure (E1) begins 1,000 micro-seconds before the end of Frame 1 readout. Finally, the 2nd WDR exposure (E2) begins 100 micro-seconds before the end of the Frame 1 readout. In this example, two line artifacts may be seen. These artifacts will be located where they occurred with respect to the readout of Frame 1 in time. For the E1 exposure, the artifact may be seen at image line 150 (1000 micro-seconds before the end of the frame readout) and, for the E2 exposure, an artifact at line 15 (100 micro-seconds before the end of the Frame 1 readout) maybe observed. If the E1 and E2 exposures do not overlap with the readout of Frame 1, no artifacts will be observed.

To eliminate these artifacts when trying to achieve maximum frame rates:

- Enable the **Fixed Frame Period** control to increase the frame time slightly so the WDR exposures occur after the frame readout ends. For example, if the minimum frame time is 20ms (50 fps) and the longest WDR exposure desired is 2ms (so the WDR exposure occurs 2ms before the end of the frame time), then use the Fixed Frame Period control to increase the frame time by 2ms to 22ms.
- Use trigger mode, WDR image artifacts will never be present, because the exposure and readout are not overlapped in triggered mode.

2.12 DATA OUTPUT FORMAT

2.12.1 Bit Depth

The internal digitization level within the image sensor can be varied to improve frame rate. 10-bit digitization level allows the on-chip A/D converters to settle more quickly enabling higher frame rates while 12-bit digitization levels provides higher dynamic range at the expense of frame rate. The camera can output the data in 12, 10 or 8-bit format. In 8-bit output, standard bit reduction process is used and the least significant bits are truncated

- “12-bit” digitization (See Figure 2.12)

If the camera is set to output 12-bit data, the image sensor data bits are mapped to D0 (LSB) to D11 (MSB) output bits.

If the camera is set to output 10-bit data, the image sensor most-significant data bits [D2 to D11] are mapped to the D0 (LSB) to D9 (MSB) output bits.

If the camera is set to output 8-bit data, the image sensor most significant data bits [D4 to D11] are mapped to D0 (LSB) to D7 (MSB)

- “10-bit” digitization (See Figure 2.13)

If the camera is set to output 12-bit data, the image sensor data bits are mapped to the D2 (LSB) to D11 (MSB) output bits and output bits D0 and D1 are set to zero.

If the camera is set to output 10-bit data, the image sensor data bits are mapped directly to D0 (LSB) to D9 (MSB)

If the camera is set to output 8-bit data, the image sensor data most significant data bits (D2 to D9) are mapped to D0 (LSB) to D7 (MSB).

Internal Camera - 12 bits											
MSB						LSB					
D11	D10	D9	D8	D7	D6	D5	D4	D3	D2	D1	D0
P11	P10	P9	P8	P7	P6	P5	P4	P3	P2	P1	P0

Camera Output - 12 bits											
MSB						LSB					
D11	D10	D9	D8	D7	D6	D5	D4	D3	D2	D1	D0
P11	P10	P9	P8	P7	P6	P5	P4	P3	P2	P1	P0

Camera Output - 10 bits									
MSB					LSB				
D9	D8	D7	D6	D5	D4	D3	D2	D1	D0
P11	P10	P9	P8	P7	P6	P5	P4	P3	P2

Camera Output - 8 bits							
MSB				LSB			
D7	D6	D5	D4	D3	D2	D1	D0
P11	P10	P9	P8	P7	P6	P5	P4

Figure 2.12: 12-bit internal Digitization with 8, 10 and 12-bit outputs

Internal Camera - 12 bits											
MSB						LSB					
D9	D8	D7	D6	D5	D4	D3	D2	D1	D0		
P9	P8	P7	P6	P5	P4	P3	P2	P1	P0		

Camera Output - 12 bits											
MSB						LSB					
D11	D10	D9	D8	D7	D6	D5	D4	D3	D2	D1	D0
P9	P8	P7	P6	P5	P4	P3	P2	P1	P0	0	0

Camera Output - 10 bits									
MSB					LSB				

D9	D8	D7	D6	D5	D4	D3	D2	D1	D0
P9	P8	P7	P6	P5	P4	P3	P2	P1	P0

MSB							Camera Output - 8 bits							LSB						
D7	D6	D5	D4	D3	D2	D1	D0	P9	P8	P7	P6	P5	P4	P3	P2					

Figure 2.13: 10-bit internal digitization with 8, 10 and 12-bit outputs

2.12.2 Output Taps

CHEETAH camera series supports Camera Link Base (1 or 2 Tap), Medium (4 tap), Full (8 tap) or Deca (10 taps). The amount of data that can be transferred per unit time increases with the number of taps selected. The camera reduces the image sensor output rate to match the bandwidth of the output based on the number of taps selected by changing the minimum line readout time. For example, if one output tap is selected, then the minimum line time is set to 15,200 clocks (~93 micro-seconds), whereas if dual output taps are selected, then the minimum line time reduces to 7550 (47 micro-seconds / line) clocks. See Table 2.7 below.

Output Taps	Min. Line Clocks	Min. Line Time (uS)	Max. C4080 Full Res. Frame Rate (fps)
1	15200	93	6.7
2	7625	47	13.3
4	3810	23	27
8	1910	12	56
10	1875	12	70

Table 2.7: Dependency of Line time and frame rate on Output Taps.

2.13 PULSE GENERATOR

The camera has a built-in pulse generator. The user can program the camera to generate a discrete sequence of pulses or a continuous trail – Figure 2.14. The pulse generator can be used as a trigger signal, or can be mapped to one of the outputs – refer to “I/O Control” section for more information. The discrete number of pulse can be set from 1 to 65535 with a step of 1. The user has options to set:

- **Granularity** – Indicates the number of clock cycles that are used for each increment of the width and the period. Four possible options are available (x1, x10, x100 and x 1000).
- **Period** – Indicates the amount of time (also determined by the granularity) between consecutive pulses. Minimum value is 1, maximum is 1,048,575
- **Width** – Specifies the amount of time (determined by the granularity) that the pulse remains at a high level before falling to a low level. Minimum value is 1, maximum is 524,287.

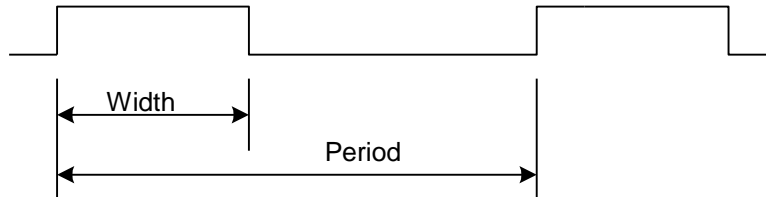

Figure 2.14: Internal pulse generator

2.14 I/O CONTROL

2.14.1 Input / Output Mapping

The camera has 2 external inputs (1 TTL input and 1 opto-coupled input) and 2 external outputs wired to the 12 pin HIROSE connector, located on the back of the camera. In addition to these inputs and outputs, Camera Link inputs (CC1 and CC2) are also available. The user can map CC1 and CC2 or either external input to the Trigger input. The user can map the camera outputs to: Trigger, Pulse Generator, Strobe One, or Strobe Two. For each mapped signal active “High”, active “Low”, can be selected. All possible mapping options for the camera inputs and outputs are shown in Table 2.8a and Table 2.8b respectively.

Input Signals	IN1	IN2	CC1	CC2
Trigger	✓	✓	✓	✓

Table 2.8a: CHEETAH Input Mapping

Output Signals	OUT1	OUT2
Trigger	✓	✓
Pulse Generator	✓	✓
Strobe One	✓	✓
Strobe Two	✓	✓

Table 2.8b: CHEETAH Output Mapping

2.14.2 Electrical Connectivity

The Cheetah has two external inputs: IN 1 and IN 2. Input “IN 1” is optically isolated, while Input “IN 2” accepts Low Voltage TTL (LVTTL). Cheetah provides two general purpose outputs. Output “OUT 1” is a 5v TTL (5.0 Volts) compatible signal and Output “OUT 2” is opto-isolated. Figure 2.15a and b shows the external input electrical connections. Figure 2.15c and d shows the external output electrical connections

A. Input IN 1- Opto-Isolated

The input signal “IN 1” and “IN 1 Rtn” are optically isolated and the voltage difference between the two must be positive between 3.3 and 20.0 volts. The maximum input voltage is +/- 20V. The normal input current is 5mA and the total maximum current **MUST NOT** exceed 20 mA.

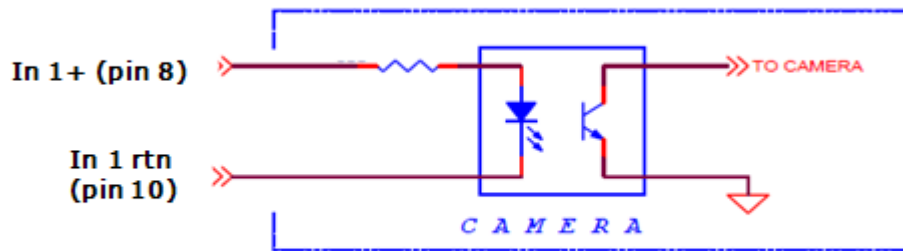

Figure 2.15a: IN1 electrical connection.

B. Input IN 2 LVTTL

The input signals “IN 2” and “IN 2 Rtn” are used to interface to a TTL or LVTTL input signal. The signal level (voltage difference between the inputs “IN 2” and “IN 2 Rtn”) **MUST** be LVTTL (3.3 volts) or TTL (5.0 volts). The total maximum input current **MUST NOT** exceed 2.0 mA.

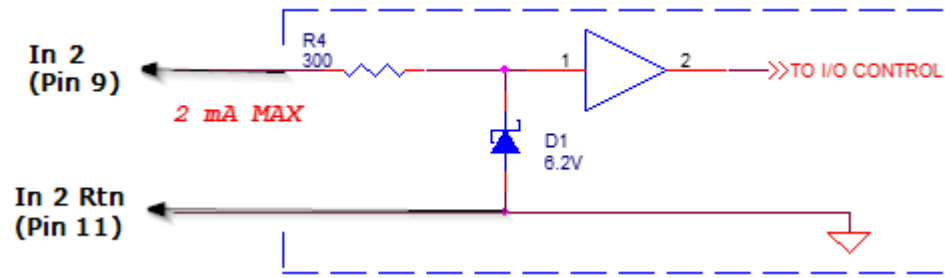

Figure 2.15b: IN 2 electrical connection

C. Output OUT 1 LVTTTL

Output OUT 1 is a 5v TTL (5.0 Volts) compatible signal and the maximum output current **MUST NOT** exceed 8 mA.

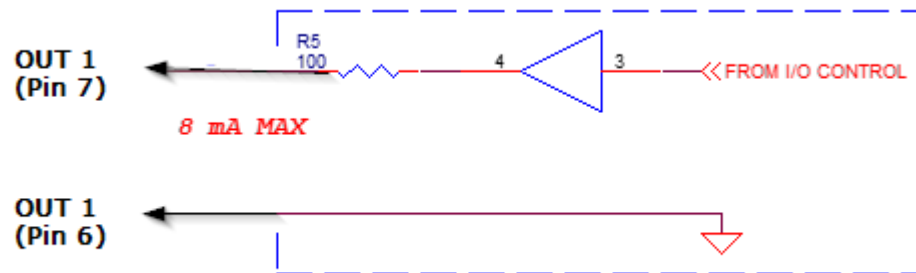

Figure 2.15c: OUT 1 LVTTTL electrical connection.

D. Output OUT 2 - Opto-isolated

Output OUT 2 is an optically isolated switch. There is no pull-up voltage on either contact. The voltage across OUT 2 Contact 1 and OUT 2 Contact 2 **MUST NOT** exceed 25 volts and the current through the switch **MUST NOT** exceed 50 mA.

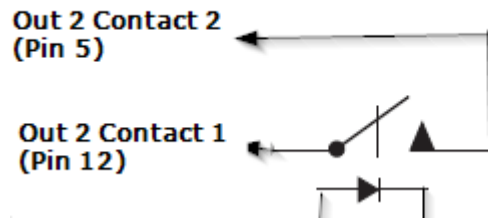

Figure 2.15d: OUT 2 Opto-Isolated electrical connection

2.15 TEST IMAGE PATTERNS

2.15.1 Test Image patterns

The camera can output several test images, which can be used to verify the camera's general performance and connectivity to the frame grabber. This ensures that all the major modules in the hardware are working properly and that the connection between the frame grabber and the camera is synchronized – i.e., the image framing, output mode, communication rate, etc. are properly configured. Please note that the test image patterns do not exercise and verify the image sensor functionality.

The following test images are available:

- **H Ramp Still** – displays a stationary horizontal ramp image
- **V Ramp Still** – displays a stationary vertical ramp image
- **H Ramp Move** – displays a moving horizontal ramp image
- **V Ramp Move** – displays a moving vertical ramp image
- **Cross-hairs** – displays a cross-hair in the absolute center of the image (2000 x 1500). A live image is superimposed under the cross-hair pattern. (Cross-hair has a thickness of 2 pixels)

2.16 WHITE BALANCE AND COLOR CONVERSION

2.16.1 White Balance Correction

The color representation in the image depends on the color temperature of the light source and CHEETAH has a built-in algorithm to compensate for this effect. When white balance correction is enabled, the camera collects the luminance data for each of the primary colors R, G and B, analyzes it, and adjusts the color setting in order to preserve the original colors and make white objects appear white. The algorithm

collects data from the entire image, and can work in four different modes – “Off”, “Once”, “AWB Tracking” and “Manual”. When set to “Off”, no color correction is performed. When set to “Once” the camera analyzes one image frame, calculates only one set correction coefficients, and all subsequent frames are corrected with this set of coefficients. When set to “Manual” the camera uses the correction coefficients as entered from the user. In “Tracking” mode the camera analyzes every frame, a set of correction coefficients are derived for each frame and applied to the next frame. When “Auto-White Balance (AWB) Tracking” mode is selected, the user can select 5 tracking speeds from slow to fastest.

2.17 TRANSFER FUNCTION CORRECTION – USER LUT

The user defined LUT (Lookup Table) feature allows the user to modify and transform the original video data into any arbitrary value – Figure 2.16. Any 12-bit value can be transformed into any other 12-bit value. The camera supports two separate lookup tables, each consisting of 4096 entries, with each entry being 12 bits wide. The first LUT is factory programmed with a standard Gamma 0.45. The second LUT is not pre-programmed in the factory. Both LUT's are available for modifications, and the user can generate and upload his own custom LUT using the CHEETAH Configuration software – refer to Appendix B.

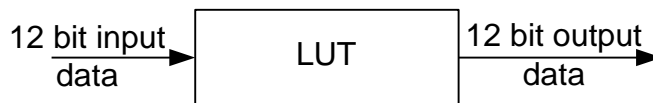

Figure 2.16: Look up table

2.17.1 Standard Gamma Correction

The image generated by the camera is normally viewed on a CRT (or LCD) display, does not have a linear transfer function – i.e., the display brightness is not linearly proportional to the scene brightness (as captured by the camera). As the object brightness is lowered, the brightness of the display correspondingly lowers. At a certain brightness level, the scene brightness decrease does not lead to a corresponding display brightness decrease. The same is valid if the brightness is increased. This is because the display has a nonlinear transfer function and a brightness dynamic range much lower than the camera. The camera has a built-in transfer function to compensate for this non-linearity, which is called gamma correction. If enabled, the video signal is transformed by a non-linear function close

to the square root function (0.45 power) – formula 2.4. In the digital domain, this is a nonlinear conversion from 12-bit to 12-bit – Figure 2.17.

$$\text{Output signal [V]} = (\text{input signal [V]})^{0.45} \quad (2.4)$$

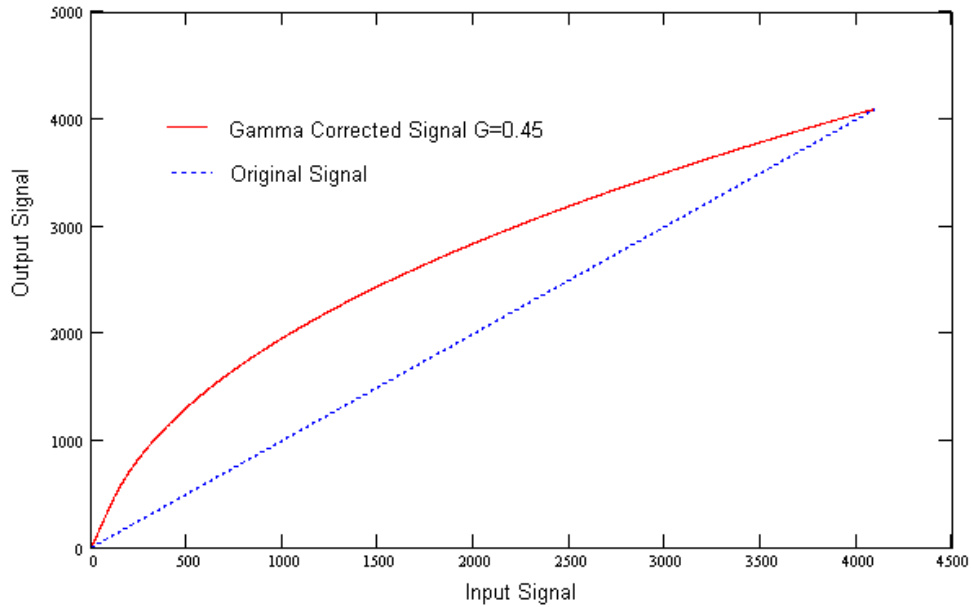

Figure 2.17: Gamma corrected video signal

2.17.2 User Defined LUT

The user can define any 12-bit to 12-bit transformation as a user LUT and can upload it to the camera using the configuration utility software. The user can specify a transfer function of their choice to match the camera's dynamic range to the scene's dynamic range. There are no limitations to the profile of the function. The LUT must include all possible input values (0 to 4095) – Figures 2.18.

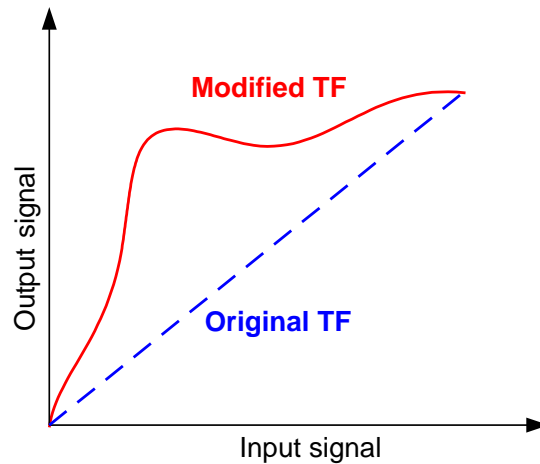

Figure 2.18: Custom LUT

2.18 DEFECTIVE PIXEL CORRECTION

A CMOS imager is composed of a two-dimensional array of light sensitive pixels. In general, the majority of the pixels have similar sensitivity. Unfortunately, there are some pixels which sensitivity deviates from the average pixel sensitivity. A defective pixel is defined as a pixel whose response deviates by more than 15% from the average response. In extreme cases, these pixels can be stuck 'black' or stuck 'white' and are non-responsive to light. There are two major types of pixel defects – "Defective" and "Hot".

1. **"Defective"** – these are pixels which sensitivity deviates more than 15% due to fluctuations in the CMOS manufacturing process. During final camera testing at the factory up to 1024 defective pixels are identified and will be automatically corrected if defective pixel correction is enabled. Two types of defective pixels are possible:
 - a. **"DARK"** is defined as a pixel, whose sensitivity is lower than the sensitivity of the adjacent pixels. In some cases, this pixel will have no response (completely dark).
 - b. **"BRIGHT"** is defined as a pixel, whose sensitivity is higher than the sensitivity of the adjacent pixels. In some cases, this pixel will have full response (completely bright).
2. **"Hot"** – these are pixels, which in normal camera operation behaves as normal pixel (the sensitivity is equal to the one of the adjacent pixels), but during long time integration behaves as a high intensity bright pixel. In some cases, this pixel will have full response (completely bright). During final camera testing at the factory, up to 8192 hot pixels will be identified and will be automatically corrected, if hot pixel correction is enabled.

2.18.1 Static Pixel Correction

Static defective and Hot pixel correction works with predetermined and preloaded Defective and Hot pixel maps. During factory final testing, our manufacturing engineers run a program specially designed to identify these 'defective' and "hot" pixels. The program creates a map file which lists the coordinates (i.e. row and column) of every defective pixel. This file, called the Defect Pixel Map, is then downloaded into the camera's non-volatile memory. Users may wish, however, to create and to upload their own DPM file because of the uniqueness of their operating environment or camera use. When 'Defective Pixel Correction' is enabled, the camera will compare each pixel's coordinates with entries in the 'defect' map. If a match is found, then the camera will 'correct' the defective pixel. When 'Hot Pixel Correction' is enabled, the camera will compare each pixel's coordinates with entries in the 'defect' map. If a match is found, then the camera will 'correct' the hot pixel. The "Defective/Hot Pixel Map" can be displayed upon user request.

2.18.2 Dynamic Pixel Correction

Dynamic pixel correction works without preloaded pixel maps. When this option is enabled, the camera determines which pixel needs correction and performs the correction automatically. Static and Dynamic "Defective Pixel Correction" and "Hot Pixel Correction" can be enabled independently or simultaneously. The Dynamic Threshold can be set to have a value between 0 to 4096 (12-bit). This threshold determines how much a pixel can deviate from neighboring pixels (either brighter or darker) before a pixel is considered to be defective and correction is applied to this pixel.

2.19 CAMERA INTERFACE

2.19.1 Status LED

The camera has a dual red-green LED, located on the back panel. The LED color and light pattern indicate the camera status and mode of operation:

- **GREEN is steady ON** – Normal operation. The user is expected to see a normal image coming out of the camera.
- **GREEN blinks with frequency ~ 0.5 Hz** – indicates trigger is enabled.
- **RED is steady ON** – Test mode enabled.

- **LED is OFF** – Power not present error. The camera has no power or indicates a camera power supply failure. A faulty external AC adapter could also cause this. To restore the camera operation, re-power the camera and load the factory settings. If the LED is still “OFF”, please contact the factory for RMA.

2.19.2 Temperature Monitor

The camera has a built in temperature sensor which monitors the internal camera temperature. The sensor is placed on the hottest spot in the camera. The internal camera temperature is displayed on the Camera Configuration Utility screen and can be queried by the user at any time – refer to Camera Configuration section.

2.19.3 Exposure Time Monitor

The camera has a built-in exposure time monitor. In any mode of operation (i.e. normal, AOI, etc.) the user can query the camera for the current exposure time by issuing a command – refer to the Exposure Control section. The current camera integration time in units of microseconds will be returned.

2.19.4 Frame Time Monitor

The camera has a built-in frame rate monitor. In any mode of operation (i.e. normal, AOI, etc.) the user can query the camera for the current frame rate by issuing a command – refer to the Exposure Control section. The current camera speed in units of frames per second will be returned.

2.19.5 Current image size

The camera image size can change based on a camera feature selected. In any mode of operation (i.e. normal, AOI, etc.) the user can query the camera for the current image size by issuing a command – refer to the Image Size section. The current camera image size in (pixels x lines) will be returned.

The graphic for Chapter 3 features the word "Chapter" in a stylized, italicized font with a white outline and a drop shadow. Below it is a large, stylized number "3" with a white outline and a drop shadow. The background of the graphic consists of three downward-pointing chevrons in red and grey, with a white chevron in the center.

Chapter 3

Camera Configuration

This chapter discusses how to communicate with the camera and configure the camera's operating parameters.

3.1 OVERVIEW

The CHEETAH series of cameras are highly programmable and flexible. All of the camera resources (internal registers, video amplifiers and parameter FLASH) can be controlled by the user. The user communicates with the camera using a simple, register-based, command protocol via the Camera Link's serial interface. The interface is bi-directional with the user issuing 'commands' to the camera and the camera issuing 'responses' (either status or info) to the user. The entire camera registers and resources can be configured and monitored by the user. The camera's parameters can be programmed using the CHEETAH Configurator graphical user interface.

3.2 CAMERA CONFIGURATION

3.2.1 Configuration Memory – parameter FLASH

The camera has a built-in configuration memory divided into 4 segments: 'work-space', 'factory-space', 'user-space #1' and 'user-space #2'. The 'work-space' segment contains the current camera settings while the camera is powered-up and operational. All camera registers are located in this space. These registers can be programmed and retrieved via commands issued by the user. The workspace is RAM based and upon power down all camera registers are cleared. The 'factory-space' segment is ROM based, write protected and contains the default camera settings. This space is available for read operations only. The 'user-space #1' and 'user-space #2' are non-volatile, FLASH based and used to store two user defined configurations. Upon power up, the camera firmware loads the work-space registers from the factory-space, user-space #1 or user-space #2 as determined by a 'boot control' register located in the configuration memory. The 'boot control' register can be programmed by the user (refer to Camera Configuration Section). The user can, at any time, instruct the camera to load its workspace with the contents of the 'factory-space', 'user-space #1' or 'user-space #2'. Similarly, the user can instruct the camera to save the current workspace settings into either the 'user-space #1' or 'user-space #2'.

The non-volatile parameter FLASH memory also contains Defective Pixel Map, Hot Pixel Map, LUT 1 and LUT 2, which can be loaded to the camera internal memory upon enabling the corresponding camera feature. The user can create its own DPM, HPM, and LUT tables and upload them to the parameter FLASH using the CHEETAH Configurator graphical user interface.

3.2.2 Camera Serial Protocol

In order to access the camera registers and resources a sequence of bytes needs to be transmitted to the camera via the Camera Link serial interface. This is an RS232, asynchronous, full-duplex, serial protocol, with 1 start bit, 8 data bits, 1 stop bit, no hand shake, and no parity – Figure 4.1. The default baud rate is configurable (9600, 19200, 38400, 57600 and 115200 – default).

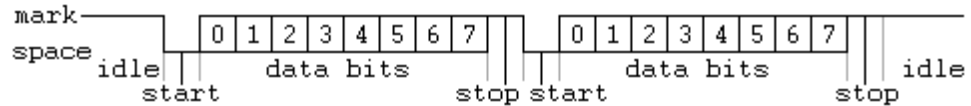

Figure 3.1: Serial protocol format

Each camera control register can be updated independently. In terms of the serial protocol, all registers are defined as 16-bit address (hex format), and 32-bit data (hex format). Camera registers using less than 32-bits in width must be padded with '0's on writes, and unused bits are ignored on reads. Register data is always “packed low” within 32-bit data words for registers defined less than 32-bits.

There is a latency delay for each command due to command execution and data transmission over the serial port. This latency varies from command to command because of resource location and command response length.

3.2.2.1 Write Operation

In order to write to any given camera register, a sequence of 7 bytes should be sent to the camera. If there is no error the camera returns one byte acknowledge for the write command <Ack> - Figure 4.2. If there is an error the camera returns two bytes not-acknowledge for the write command – the first byte is <Nac> <Err>, the second is the error code – Figure 4.3a,b:

Write to camera (7 Bytes): <Write_Cmd> <Address> <Data>

- 1st byte: 0x57 (Write Command)
- 2nd byte: <Register Address_High> MSB
- 3rd byte: <Register Address_Low> LSB
- 4th byte: <Register Data Byte 4> MSB
- 5th byte: <Register Data Byte 3> ...
- 6th byte: <Register Data Byte 2> ...
- 7th byte: <Register Data Byte 1> LSB

Write Acknowledge (1 Byte): <Ack>

1st byte: 0x06 (Acknowledge)

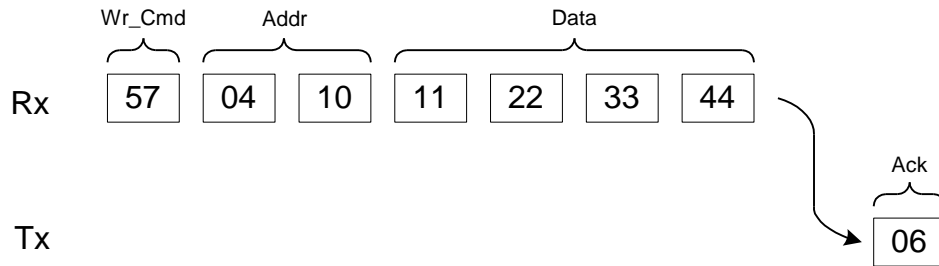

Figure 3.2: Normal write cycle

Write Not-acknowledge (2 Bytes): <Nac> <Error Code>

1st byte: 0x15 (Not-acknowledge)

2nd byte: <XX> (Nac Error Code. See Error Code Description section)

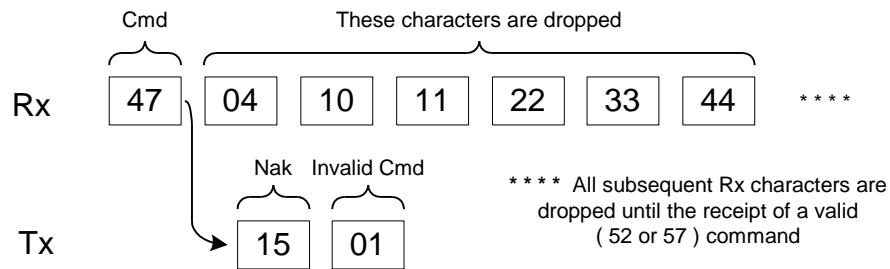

Figure 3.3a: Invalid command error

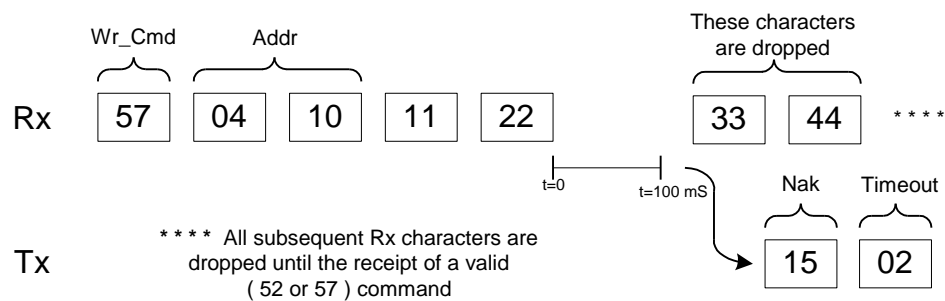

Figure 3.3b: Rx timeout error

Example: Write to register address 0x0410, data value = 0x11223344:

⇒ Camera Write Command: <0x57> <04> <10> <11> <22> <33> <44>

3.2.2.2 Read Operation

In order to read from any given camera register, a sequence of 3 bytes should be sent to the camera. If there is no error the camera returns 5 bytes – one byte acknowledge for the read command <Ack> and four bytes of data <DD> <DD> <DD> <DD> - Figure 4.4. During read operation the camera does not return an error or <Nac>. The only exception is the case of invalid command – Figure 4.3a. If the user specifies a wrong address, the camera returns acknowledge <06> and four bytes of data <00> <00> <00> <00>.

Read from camera (3 Bytes) : <Read_Cmd> <Address>

- 1st byte: 0x52 (Read Command)
- 2nd byte: <Register Address_High> MSB
- 3rd byte: <Register Address_Low> LSB

The camera returns (5 bytes): <ACK> <Data>

- 1st byte: 0x06 (Acknowledge)
- 2nd byte: <Register Data Byte 4> MSB
- 3rd byte: <Register Data Byte 3> ...
- 5th byte: <Register Data Byte 2> ...
- 6th byte: <Register Data Byte 1> LSB

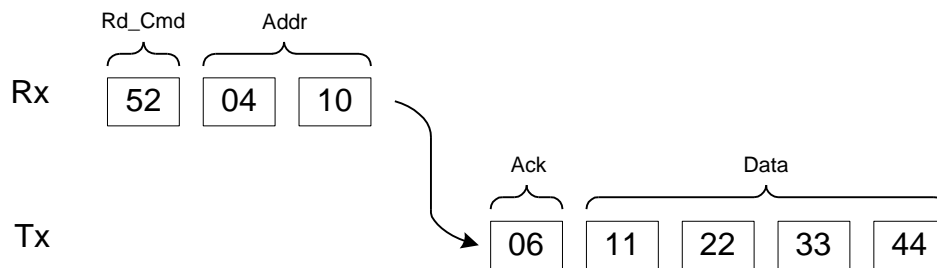

Figure 3.4: Normal read cycle

Example: Read from camera register address 0x0410:

⇒ Camera Read Command: <0x52> <04> <10>

Camera returns register data payload value 0x11223344:

⇒ Register data <0x06> <11> <22> <33> <44>

3.2.2.3 Error Code Description

To manage camera reliability, not-acknowledge error codes are defined as follows:

- x00 – No error
- x01 – Invalid command. An invalid command (not 52 or 57) has been sent to the camera.
- x02 – Time-out.
- x03 – Checksum error
- x04 – Value less than minimum
- x05 – Value higher than maximum
- x06 – AGC error
- x07 – Supervisor mode error
- x08 – Mode not supported error

3.3 CAMERA CONFIGURATION REGISTER DESCRIPTION

3.3.1 Startup Procedure

Upon power on or receipt of a `'SW_Reset'` command, the camera performs the following steps:

1. Boot loader checks Program FLASH memory for a valid Firmware image and loads it into the FPGA.
2. The camera reads the 'Boot From' register from the parameter FLASH and loads its workspace from one of the configuration spaces as determined by the 'Boot From' data. The available configuration spaces are: `'Factory...'`, `'User #1...'`, `'User #2...'`
3. The camera is initialized and ready to accept user commands.

3.3.2 Saving and Restoring Settings

Operational settings for the camera may be stored for later retrieval in its non-volatile memory. Three separate configuration spaces exist for storing these settings: 'factory' space, 'user #1' space and 'user #2' space. The factory space is pre-programmed by factory personnel during the manufacturing process. This space is write protected and cannot be altered by the user. Two user spaces are also provided allowing the user to store his/her own preferences. The camera can be commanded to load its internal workspace, from either of the three configuration spaces, at any time. The user can also define from which space the

camera should automatically load itself following a power cycle or receipt of a reset ('SW_Reset') command.

3.3.2.1 Boot From

This register determines which configuration space (factory, user#1 or user #2) should be loaded into the camera following a power cycle or reset ('SW_Reset') command. Upon a power cycle or reset, the camera reads the 'boot from' value from non-volatile memory and loads the appropriate configuration space.

Address	:	0x6000
Data (1- 0)	:	00 – Boot from Factory
		01 – Boot from User #1
	:	10 – Boot from User #2
Data (31- 2)	:	N/A

3.3.2.2 Load From Factory

The 'Load From Factory' command instructs the camera to load its workspace from the factory space. All current workspace settings will be replaced with the contents of the factory space. This is a command, not a register. The act of writing to this location initiates the load from the factory.

Address : 0x6060

3.3.2.3 Load From User #1

The 'Load From User #1' command instructs the camera to load its workspace from the user #1 space. All current workspace settings will be replaced with the contents of the user #1 space. This is a command, not a register. The act of writing to this location initiates the load from the user #1.

Address : 0x6064

3.3.2.4 Load From User #2

The 'Load From User #2' command instructs the camera to load its workspace from the user #2 space. All current workspace settings will be replaced with the contents of the user #2 space. This is a command, not a register. The act of writing to this location initiates the load from the user #2.

Address : 0x6068

3.3.2.5 Save to User #1

The 'Save To User #1' command instructs the camera to save its workspace to the user #1 space. All current workspace settings will be saved to the user #1 space. This is a command, not a register. The act of writing to this location initiates the save to user #1 space.

Address : 0x6074

3.3.2.6 Save to User #2

The 'Save To User #2' command instructs the camera to save its workspace to the user #2 space. All current workspace settings will be saved to the user #2 space. This is a command, not a register. The act of writing to this location initiates the save to user #2 space.

Address : 0x6078

3.3.2.7 SW_Reset

The 'SW_Reset' command instructs the camera to initiate software reset, which resets the camera and loads its workspace from one of the configuration spaces as determined by the 'Boot From' data. Although, this is a command, the user MUST write a specific data 0xDEADBEEF in order to initiate the reset sequence.

Address : 0x601C

Data : 0xDEADBEEF

3.3.3 Retrieving Manufacturing Data

The camera contains non-volatile memory that stores manufacturing related information. This information is programmed in the factory during the manufacturing process.

3.3.3.1 Firmware Revision

This register returns the camera main firmware revision.

Address : 0x6004

Data (31:28) : <FW image>

Data (27:24) : <CMOS Type>

Data (23:0) : <FW revision>

3.3.3.2 Firmware Build Number

This register returns the firmware build number, which tracks custom firmware for specific applications.

Address : 0x6038
Data : <FPGA, EPCS ID, Customer ID>

3.3.3.3 Assembly Part Number

This register returns the camera assembly part number – the complete assembly part number is 4 registers.

Address : 0x7004, 0x7008, 0x700C, 0x7010
Data : <Assembly Part Number>

3.3.3.4 Camera Serial Number

This register returns the camera serial number – the complete serial number is 2 registers.

Address : 0x7014, 0x7018
Data : <Camera Serial Number>

3.3.3.5 CMOS Serial Number

This register returns the CMOS imager number – the complete CMOS number is 2 registers.

Address : 0x701C, 0x7020
Data : <CMOS Image Sensor Serial Number>

3.3.3.6 Date of Manufacture

This register returns the camera date of manufacture – The complete date of manufacture is 2 registers.

Address : 0x7024, 0x7028
Data : <Date of Manufacture>

3.3.3.7 Camera Type

This register returns the camera type – The complete assembly is 4 registers.

Address : 0x7040,
Data : <Camera Type: 0x0 = Mono, 0xC= Color>

Sensor Type (0x7040) 0x0=Mono, 0xC=Color

3.3.4 Camera Information Registers

The camera has a set of information registers, which provide information for the camera current status, frame rate, exposure time, image size, etc.

3.3.4.1 Current Frame “A” Horizontal Frame Size

This register returns the current horizontal image frame size in pixels.

Address	:	0x6090
Data (15:0)	:	<Current Horizontal Size>
Data (31:16)	:	<N/A>

3.3.4.2 Current Frame “A” Vertical Frame Size

This register returns the current vertical image frame size in lines.

Address	:	0x6094
Data (15:0)	:	<Current Vertical Size>
Data (31:16)	:	<N/A>

3.3.4.3 Current Frame “B” Horizontal Frame Size

This register returns the current horizontal image frame size in pixels.

Address	:	0x6098
Data (15:0)	:	<Current Horizontal Size>
Data (31:16)	:	<N/A>

3.3.4.4 Current Frame “B” Vertical Frame Size

This register returns the current vertical image frame size in lines.

Address	:	0x609C
Data (15:0)	:	<Current Vertical Size>
Data (31:16)	:	<N/A>

3.3.4.5 Current Frame “A” Frame Time

This register returns the current frame time for Frame A in us.

Address	:	0x6084
Data (23:0)	:	< Frame Time>
Data (31:24)	:	N/A

3.3.4.6 Current Frame “B” Frame Time

This register returns the current frame time for Frame B in us.

Address	:	0x608C
Data (23:0)	:	< Frame Time>

Data (31:24) : N/A

3.3.4.7 Current Minimum Frame “A” Line Time

This register returns the current minimum line time for Frame “A” in pixel clocks (160 MHz, 6.25nS)

Address : 0x60B0
Data (15:0) : <Minimum Line Time>
Data (31- 16) : N/A

3.3.4.8 Current Minimum Frame “B” Line Time

This register returns the current minimum line time for Frame “B” in pixel clocks (160 MHz, 6.25nS)

Address : 0x60B4
Data (15:0) : <Minimum Line Time>
Data (31- 16) : N/A

3.3.4.9 Current Frame “A” Exposure

This register returns the current Frame A camera exposure time in us.

Address : 0x6080
Data (23:0) : <Camera Exposure>
Data (31:24) : N/A

3.3.4.10 Current Frame “B” Exposure

This register returns the current Frame B camera exposure time in us.

Address : 0x6088
Data (23:0) : <Camera Exposure>
Data (31:24) : N/A

3.3.4.11 Horizontal Image Size Maximum

This register returns the maximum horizontal image size in pixels.

Address : 0x60A4
Data (15:0) : <Maximum Horizontal Size>
Data (31:16) : N/A

3.3.4.12 Vertical Image Size Maximum

This register returns the maximum vertical image size in pixels

Address : 0x60A8
Data (15:0) : < Maximum Vertical Size>

Data (31:16) : N/A

3.3.4.13 Current Camera Temperature

This register returns the current camera temperature in degrees Celsius. The temperature resolution is 0.25°C – Table 4.0.

Address : 0x6010
 Data (9:0) : <Current Camera Temperature>
 Data (31:10) : N/A

Temperature	Register Value
+127.75 °C	01 1111 1111
...	...
+0.25 °C	00 0000 0001
0° C	00 0000 0000
-0.25 °C	11 1111 1111
...	...
-128 °C	10 0000 0000

Table 3.0: Current camera temperature values

3.3.5 Frame “A” Workspace Registers

3.3.5.1 Frame “A” Exposure Control

These registers control the Frame “A” Exposure

Address : 0x0720
 Data (1:0) : 00 – Off (Free Running)
 01 – Trigger Pulse Width (Duration of selected trigger pulse determines exposure time)
 10 – Internal (Exposure Control Register sets exposure time in micro-seconds)
 11 – Reserved
 Data (15:2) : N/A

Frame “A” Integration Line (Line Counter)

Address : 0x0728
 Data (15:0) : <value> Exposure time in lines (cannot exceed number of lines per frame)

Frame “A” Integration clocks (Partial Line Counter)

Address : 0x72C
 Data (15:0) : <value> Exposure time in pix clks (6.25 nS per tic) (Cannot exceed the Line Time)

3.3.5.2 Frame "A" Fixed Frame Period Enable

This register enables the Frame A Fixed Frame Period

Address	:	0x0700
Data (0)	:	0 – disable 1 – enable
Data (31:1)	:	N/A

3.3.5.3 Frame "A" Fixed Frame Period (Adds V-blanking lines)

This register sets the Frame "A" period

Address	:	0x0704
Data (15:0)	:	<value> frame period in lines (65,535 maximum)
Data (31:16)	:	N/A

3.3.5.4 Frame "A" Line Time

This register sets the Frame "A" line time by adding additional clocks to each line readout. Frame "A" line time must be greater than or equal to Minimum Frame "A" line time is specified in Register 60B0. Each pixel clock is 6.25nS.

Address	:	0x0710
Data (15:0)	:	<value> line time in pixel clks (65,535 maximum)
Data (31:16)	:	N/A

3.3.5.5 Frame "A" Area of Interest

These set of registers defines the Area of Interest and sets the appropriate window size and offset in horizontal and vertical direction.

Frame "A" AOI Horizontal Offset

Address	:	0x0008
Data (11:0)	:	<value> AOI horizontal offset (multiple of 8)
Data (31:12)	:	N/A

Frame "A" AOI Horizontal Width

Address	:	0x000C
Data (12:0)	:	<value> AOI horizontal width (multiple of 8)
Data (31:13)	:	N/A

Frame "A" AOI Vertical Offset

Address	:	0x0000
Data (11:0)	:	<value> AOI vertical offset (multiple of 2)
Data (31:12)	:	N/A

Frame "A" AOI Vertical Height

Address : 0x0004
Data (11:0) : <value> AOI vertical height (multiple of 2)
Data (31:12) : N/A

3.3.5.6 Frame "A" Decimation (Averaging or Subsampling)**Frame "A" Decimation Mode**

This register sets Frame "A" decimation mode: Averaging or Subsampling

Address : 0x073C
Data (1:0) : 00 – decimation off
 01 – Subsampling enable
 10 – Averaging enable
 11 – N/A
Data (31:2) : N/A

Frame "A" Subsampling Parameter N

This register sets Frame "A" subsampling parameter N

Address : 0x0740
Data (3:0) : <Frame "A" subsampling parameter N value>
Data (31:4) : N/A

Frame "A" Subsampling Parameter M

This register sets the Frame "A" subsampling parameter M. (M>N)

Address : 0x0744
Data (3:0) : <Frame "A" subsampling parameter M value>
Data (31:4) : N/A

Frame "A" Averaging Type

This register sets the Frame A averaging level.

Address : 0x0778
Data (0) : 0 – 4 into 1
 1 – 9 into 1

Data (31:1) : N/A

3.3.5.7 Frame "A" Black Level

This register controls the Frame A Black Level.

Address : 0x0050
Data (13:0) : <value> Target Black Level in DN
Data (15:14) : N/A

3.3.5.8 Frame "A" Analog & Digital Gain

Frame "A" Analog Gain

This register controls the Frame A analog gains. Analog gains should always be applied before digital gain.

Address : 0x0748
Data (5:0) : < analog gain value>
Data (31:6) : N/A

Frame "A" Digital Gain (Fine Control)

This register sets the Frame "A" digital gain fine control

Address : 0x074C
Data (5:0) : <digital gain fine value>
Data (31:6) : N/A

Frame "A" Digital Gain (Course Control)

This register sets Frame "A" Course Digital Gain

Address : 0x0750
Data (1:0) : 00 - Course gain 1x to 2x
 : 01 - Course gain 2x to 4x
 : 10 - Course gain 4x to 8x
 : 11 - Course gain 8x to 15x
Data (31:2) : N/A

3.3.5.9 Wide Dynamic Range (WDR) Registers

These set of registers controls the Wide Dynamic Range Function

Frame "A" WDR Enable

Address : 0x0600
Data (0) : 0 – Disable
 : 1 – Enable

Data (31:1) : N/A

Frame "A" WDR P1 Level

Address : 0x0604
Data (3:0) : 0000 – 100%
 : 0001 – 90%
 : 0010 – 80%
 : 0011 – 75%
 : 0100 – 70%
 : 0101 – 65%
 : 0110 – 60%
 : 0111 – 55%
 : 1000 – 50%
 : 1001 – 45%
 : 1010 – 40%
 : 1011 – 35%
 : 1100 – 30%
 : 1101 – 25%
 : 1110 – 20%
 : 1111 – 15%

Data (31:1) : N/A

Frame "A" WDR P2 Level

Address : 0x0608
Data (3:0) : 0000 – 100%
 : 0001 – 90%
 : 0010 – 80%
 : 0011 – 75%
 : 0100 – 70%
 : 0101 – 65%
 : 0110 – 60%
 : 0111 – 55%
 : 1000 – 50%
 : 1001 – 45%
 : 1010 – 40%

1011 – 35%
1100 – 30%
1101 – 25%
1110 – 20%
1111 – 15%
Data (31:1) : N/A

Frame “A” WDR P3 Level

Address : 0x060C
Data (3:0) : 0000 – 100%
0001 – 90%
0010 – 80%
0011 – 75%
0100 – 70%
0101 – 65%
0110 – 60%
0111 – 55%
1000 – 50%
1001 – 45%
1010 – 40%
1011 – 35%
1100 – 30%
1101 – 25%
1110 – 20%
1111 – 15%
Data (31:1) : N/A

Frame “A” WDR E1 (Bright Pixel exposure period)

Address : 0x0610
Data (19:0) : <value> E1 exposure time in micro-sec., 1 sec max
Data (31:20) : N/A

Frame “A” WDR E2 (Very-Bright Pixel Exposure period)

Address : 0x0614
Data (19:0) : <value> E2 exposure time in micro-sec., 1 sec max
Data (31:20) : N/A

Frame “A” WDR E3 (Ultra-Bright Pixel Exposure period)

Address : 0x0660
Data (19:0) : <value> E3 exposure time in micro-sec., 1 sec max
Data (31:20) : N/A

3.3.6 Frame "B" Workspace Registers

3.3.6.1 Frame "B" Exposure Control

This register controls the Frame "B" Exposure Control

Address	:	0x0724
Data (1:0)	:	00 – Off (Free Running) 01 – Trigger Pulse Width (Duration of selected trigger pulse determines exposure time) 10 – Internal (Exposure Control Register sets exposure time in micro-seconds) 11 – Reserved
Data (15:2)	:	N/A

Frame "B" Integration Lines (Line Counter)

Address	:	0x0730
Data (15:0)	:	<value> Exposure time in lines (cannot exceed number of lines per frame)

Frame "B" Integration Clocks (Partial Line Counter)

Address	:	0x734
Data (15:0)	:	<value> Exposure time in pix clks (6.25 nS per tic) (Cannot exceed the Line Time)

3.3.6.2 Frame "B" Fixed Frame Period Enable

This register enables the Frame B Fixed Frame Period

Address	:	0x0708
Data (0)	:	0 – disable 1 – enable
Data (31:1)	:	N/A

3.3.6.3 Frame "B" Fixed Frame Period (adds V-Blanking Lines)

This register sets the Frame "B" period

Address	:	0x070C
Data (15:0)	:	<value> frame period in lines (65,535 maximum)
Data (31:16)	:	N/A

3.3.6.4 Frame "B" Line Time

This register sets the Frame "B" line time by adding additional clocks to each line readout. The Frame "B" line time must be greater than or equal to the

Frame “B” minimum line time specified in Register 60B4. Each pixel clock equals 6.25nS.

Address	:	0x0714
Data (15:0)	:	<value> line time in pixel clocks 65,535 maximum)
Data (31:16)	:	N/A

3.3.6.5 Frame “B” Area of Interest

These set of registers defines the Area of Interest and sets the appropriate window size and offset in horizontal and vertical direction.

Frame “B” AOI Horizontal Offset

Address	:	0x0108
Data (11:0)	:	<value> AOI horizontal offset (multiple of 8)
Data (31:12)	:	N/A

Frame “B” AOI Horizontal Width

Address	:	0x010C
Data (12:0)	:	<value> AOI horizontal width (multiple of 8)
Data (31:13)	:	N/A

Frame “B” AOI Vertical Offset

Address	:	0x0100
Data (11:0)	:	<value> AOI vertical offset (multiple of 2)
Data (31:12)	:	N/A

Frame “B” AOI Vertical Height

Address	:	0x0104
Data (11:0)	:	<value> AOI vertical height (multiple of 2)
Data (31:12)	:	N/A

3.3.6.6 Frame “B” Decimation (Averaging or Subsampling)

Frame “B” Decimation Mode

This register sets Frame “B” decimation mode: Averaging or Subsampling

Address	:	0x0754
Data (1:0)	:	00 – decimation off 01 – Subsampling enable 10 – Averaging enable 11 – N/A
Data (31:2)	:	N/A

Data (5:0) : <digital gain fine value>
Data (31:6) : N/A

Frame “B” Digital Gain (Course Control)

This register sets the Frame “B” Course Digital Gain.

Address : 0x0768
Data (1:0) : 00 - Course gain 1x to 2x
 : 01 - Course gain 2x to 4x
 : 10 - Course gain 4x to 8x
 : 11 - Course gain 8x to 15x
Data (31:2) : N/A

3.3.6.9 Frame B Wide Dynamic Range (WDR) Registers

These set of registers controls the Wide Dynamic Range Function

Frame “B” WDR Enable

Address : 0x0618
Data (0) : 0 – Disable
 : 1 – Enable

Data (31:1) : N/A

Frame “B” WDR P1 Level

Address : 0x061C
Data (3:0) : 0000 – 100%
 : 0001 – 90%
 : 0010 – 80%
 : 0011 – 75%
 : 0100 – 70%
 : 0101 – 65%
 : 0110 – 60%
 : 0111 – 55%
 : 1000 – 50%
 : 1001 – 45%
 : 1010 – 40%
 : 1011 – 35%
 : 1100 – 30%
 : 1101 – 25%
 : 1110 – 20%
 : 1111 – 15%
Data (31:4) : NA

Frame “B” WDR P2 Level



Address : 0x0620
Data (3:0) : 0000 – 100%
0001 – 90%
0010 – 80%
0011 – 75%
0100 – 70%
0101 – 65%
0110 – 60%
0111 – 55%
1000 – 50%
1001 – 45%
1010 – 40%
1011 – 35%
1100 – 30%
1101 – 25%
1110 – 20%
1111 – 15%
Data (31:4) : NA

Frame “B” WDR P3 Level (Normally set to 100%)

Address : 0x0624
Data (3:0) : 0000 – 100%
0001 – 90%
0010 – 80%
0011 – 75%
0100 – 70%
0101 – 65%
0110 – 60%
0111 – 55%
1000 – 50%
1001 – 45%
1010 – 40%
1011 – 35%
1100 – 30%
1101 – 25%
1110 – 20%
1111 – 15%
Data (31:4) : NA

Frame “B” WDR E1 (Bright Pixel exposure period)

Address : 0x0628
Data (19:0) : <value> E1 exposure time in micro-sec., 1 sec max
Data (31:20) : N/A

Frame “B” WDR E2 (Ultra-Bright Pixel Exposure period)

Address : 0x062C
Data (19:0) : <value> E2 exposure time in micro-sec., 1 sec max
Data (31:20) : N/A

Frame “B” WDR E3 (Ultra-Bright Pixel Exposure period)

Address : 0x0664
Data (19:0) : <value> E3 exposure time in micro-sec., 1 sec max
Data (31:20) : N/A

3.3.7 Acquisition Control Registers

3.3.7.1 Frame Mode

This register selects the acquisition mode either (Frame “A”, Frame “B” or Dual Video)

Address : 0x07FC
Data (1:0) : 00 – Frame A active only
 01 – Frame B active only
 10 – Dual Video (automatic or triggered)
 11 – Dual Video Trigger
Data (31:2) : N/A

3.3.7.2 Dual Video Frame “A” Repetition

This register sets the number of Frame “As” which are output before switching to output Frame “Bs” in Dual Video modes.

Address : 0x0718
Data (7:0) : <value> number of Frame “As”
Data (31:8) : N/A

3.3.7.3 Dual Video Frame “B” Repetition

This register sets the number of Frame “Bs” which are output after switching from Frame “A” output in Dual Video modes.

Address : 0x071C
Data (7:0) : <value> number of Frame “As”
Data (31:8) : N/A

3.3.8 Triggering Workspace Registers

3.3.8.1 Trigger Input Selector

This register selects the triggering source.

Address	:	0x0650
Data (2:0)	:	000 – IN1 – the camera expects the trigger to come from the external source mapped to the IN1 connection within the power and I/O connector. 001 – IN2– the camera expects the trigger to come from the external source mapped to the IN2 connection within the power and I/O connector. 010 – CC1– the camera expects the trigger to come from the Camera Link cable signal CC1 011 – CC2– the camera expects the trigger to come from the Camera Link cable signal CC2. 100 – Internal – the camera expects the trigger to come from the programmable pulse generator. 101– Software trigger -expects a one clock cycle pulse generated by the computer. The trigger exposure is internal register controlled. Pulse duration exposure is not supported. 110 to 111 – N/A
Data (31:3)	:	N/A

3.3.8.2 Trigger Enable

This register enables or disables the triggering operation

Address	:	0x0654
Data (0)	:	1 – trigger is disabled, free running mode 0 – trigger is enabled – camera is in trigger mode
Data (31:1)	:	N/A

3.3.8.3 Software Trigger Start

The 'Start SW Trigger' command instructs the camera to generate one short trigger pulse. This is a command, not a register. The act of writing to this location initiates the pulse generation.

Address	:	0x6030
---------	---	--------

3.3.8.4 Triggering Edge Selector

This register selects the triggering edge – Rising or Falling.

Address	:	0x0658
Data (0)	:	0 – rising edge 1 – falling edge
Data (31:1)	:	N/A

3.3.8.5 Trigger De-bounce Time

This register selects the trigger signal de-bounce time. Any subsequent trigger signals coming to the camera within the de-bounce time interval will be ignored.

Address	:	0x065C
Data (2:0)	:	000 – no de-bounce 001 – 10 μ s de-bounce time 010 – 50 μ s de-bounce time 011 – 100 μ s de-bounce time 100 – 500 μ s de-bounce time 101 – 1.0 ms de-bounce time 110 – 5.0 ms de-bounce time 111 – 10.0 ms de-bounce time
Data (31:3)	:	N/A

3.3.9 Strobe Control Registers

These registers enable and control the position and pulse width of the two available strobes. The strobe signal is mapped to one or both of the available strobe outputs.

3.3.9.1 Strobe 1 Enable

This register enables Strobe 1

Address	:	0x0630
Data (1:0)	:	00 – disable 01 – enable for Frame A only (exposure period) 10 – enable for Frame B only (exposure period) 11 – enable for both Frame A and B
Data (31:2)	:	N/A

3.3.9.2 Strobe 1 Reference Select

This register sets the reference for the strobe 1 Start.

Address	:	0x0634
Data (0)	:	0 – Exposure Start

Data (31:1) : 1 – Readout Start
N/A

3.3.9.3 Strobe 1 Delay

This register sets the strobe 1 delay from the selected Reference.

Address : 0x0638
Data (19:0) : <value> – delay in micro sec., 1 sec max.
Data (31:20) : N/A

3.3.9.4 Strobe 1 Width

This register sets the strobe 1 pulse duration.

Address : 0x063C
Data (19:0) : <value> –width in micro sec., 1 sec max.
Data (31:20) : N/A

3.3.9.5 Strobe 2 Enable

This register enables Strobe 2

Address : 0x0640
Data (1:0) : 00 – disable
01 – enable for Frame A only (exposure period)
10 – enable for Frame B only (exposure period)
11 – enable for both Frame A and B
Data (31:2) : N/A

3.3.9.6 Strobe 2 Reference Select

This register sets the reference for the strobe 2 start.

Address : 0x0644
Data (0) : 0 – Exposure Start
1 – Readout Start
Data (31:1) : N/A

3.3.9.7 Strobe 2 Delay

This register sets the strobe 2 delay from the selected Reference

Address : 0x0648
Data (19:0) : <value> – delay in micro sec., 1 sec max.
Data (31:20) : N/A

3.3.9.8 Strobe 2 Width

This register sets the strobe 2 pulse duration.

Address : 0x064C
Data (19:0) : <value> – width in micro sec., 1 sec max.
Data (31:20) : N/A

3.3.10 Pulse Generator Workspace Registers

3.3.10.1 Pulse Generator Timing Granularity

This register sets the pulse generator main timing resolution. The main resolution is in microseconds, and 4 granularity steps are possible – x1, x10, x100, x1000 (x1000 is equal to 1ms timing resolution).

Address : 0x0690
Data (1:0) : 00 – x1
 01 – x10
 10 – x100
 11 – x1000
Data (31:2) : N/A

3.3.10.2 Pulse Generator Pulse Width

This register sets the value of the pulse width in microseconds.

Address : 0x0694
Data (18:0) : <value> – pulse width in microseconds
Data (31:19) : N/A

3.3.10.3 Pulse Generator Pulse Period

This register sets the value of the pulse period in microseconds.

Address : 0x0698
Data (19:0) : <value> – pulse width in microseconds
Data (31:20) : N/A

3.3.10.4 Pulse Generator Number of Pulses

This register sets the number of the pulses generated when the Pulse Generator Mode is set to Burst Mode (discrete number of pulses)

Address : 0x069C
Data (15:0) : <value> – number of discrete pulses
Data (31:16) : N/A

3.3.10.5 Pulse Generator Mode

This register sets the Pulse Generator to either continuous mode or burst mode.

Address	:	0x06A4
Data (0)	:	0 – Continuous Mode - continuous pulse generation 1 – Burst Mode - Generate discrete number of pulses (see Pulse Generator Number of Pulses section, register 0x069C)
Data(31:1)	:	N/A

3.3.10.6 Pulse Generator Enable

This register enables the pulse generator.

Address	:	0x06A0
Data (0)	:	0 – disable pulse generator operation 1 – enable pulse generator operation
Data (31:1)	:	N/A

3.3.11 Test Pattern Workspace Registers

3.3.11.1 Test Mode Select

This register selects the test mode pattern.

Address	:	0x0428
Data (3:0)	:	000 – no test pattern 001 – steady horizontal image ramp 010 – steady vertical image ramp 011 – moving horizontal image ramp 100 – moving vertical image ramp 101 – crosshairs superimposed over live image 110 – reserved 111 – reserved
Data (31:4)	:	N/A

3.3.12 Input/output Workspace Registers

3.3.12.1 OUT1 Output Polarity

This register sets the polarity (active Low or High) for the OUT1 output.

Address	:	0x0680
Data (0)	:	0 – active LOW 1 – active HIGH

Data (31:1) : N/A

3.3.12.2 OUT1 Output Mapping

This register maps the various internal signals to OUT1 camera output.

Address : 0x0684
Data (2:0) : 000 – no mapping
 001 – trigger pulse
 010 – pulse generator
 011 – Strobe 1
 100 – Strobe 2
 1XX – reserved
Data (31:3) : N/A

3.3.12.3 OUT2 Output Polarity

This register sets the polarity (active Low or High) for the OUT2 output.

Address : 0x0688
Data (0) : 0 – active LOW
 1 – active HIGH
Data (31:1) : N/A

3.3.12.4 OUT2 Output Mapping

This register maps the various internal signals to OUT2 camera output.

Address : 0x068C
Data (2:0) : 000 – no mapping
 001 – trigger pulse
 010 – pulse generator
 011 – Strobe 1
 100 – Strobe 2
 1XX – Reserved
Data (31:3) : N/A

3.3.13 Data Output Bit Depth/Format Selector

This register selects the bit depth output for the camera.

Address : 0x040C
Data (1:0) : 00 – 8-bit
 01 – 10-bit
 10 – 12-bit
Data (31:2) : N/A

3.3.13.1 Data Format Selector

This register selects the tap format for the camera data output.

Address	:	0x0424
Data (2:0)	:	001 – 2 tap 010 – 4 tap 011 – 8 tap 100 – 10 tap Others – reserved
Data (31:2)	:	N/A

3.3.14 White Balance (WB) Workspace Registers

3.3.14.1 WB Select

This register selects which white balance mode will be used – Off, Once, Auto or Manual.

Address	:	0x0538
Data (0:2)	:	000 – Off 001 – WB Once 010 – WB Auto Tracking 011 – WB Manual 1XX – Reserved
Data (31:3)	:	N/A

3.3.14.2 Automatic White Balance (AWB) tracking

The camera will automatically track the scene and adjust white balance according to five different tracking rates.

Address	:	0x053C
Data (0:2)	:	000 – 1x; slowest 001 – 2x 010 – 3x 011 – 4x 100 – 5x fastest (no tracking) Others - unused
Data (31:12)	:	N/A

3.3.14.3 WBC Red Coefficient

This register contains the white balance correction coefficients for Red. In manual mode, the user enters the value, in once or Auto, the camera returns

the actual (calculated) coefficient. Coefficient values range from 0.000 (0 Hex) to +15.996 (FFF Hex) in steps of 0.004 (4096 steps).

Address : 0x0540
Data (0:11) : <value> - WBC Red
Data (31:12) : N/A

3.3.14.4 WBC Green Coefficient

This register contains the white balance correction coefficients for Green. In manual mode, the user enters the value, in Once or Auto, the camera returns the actual (calculated) coefficient. Coefficient values range from 0.000 (0 Hex) to +15.996 (FFF Hex) in steps of 0.004 (4096 steps).

Address : 0x0544
Data (0:11) : <value> - WBC Green
Data (31:12) : N/A

3.3.14.5 WBC Blue Coefficient

This register contains the white balance correction coefficients for Blue. In manual mode, the user enters the value, in Once or Auto, the camera returns the actual (calculated) coefficient. Coefficient values range from 0.000 (0 Hex) to +15.996 (FFF Hex) in steps of 0.004 (4096 steps).

Address : 0x0548
Data (0:11) : <value> - WBC Blue
Data (31:12) : N/A

3.3.15 Data Correction Workspace Registers

3.3.15.1 LUT Select

This register selects which LUT will be used – LUT1 or LUT2.

Address : 0x0410
Data (0) : 0 – LUT #1 selected
 : 1 – LUT #2 selected
Data (31:1) : N/A

3.3.15.2 LUT Enable

This register enables the selected LUT.

Address : 0x0414
Data (0) : 0 – disable
 : 1 – enable
Data (31:1) : N/A

3.3.15.3 Defective Pixel Correction (DPC) Enable

This register enables the DPC (Defective Pixel Correction).

Address	:	0x0418
Data (1:0)	:	00 – DPC disable 01 – Static DPC enable 10 – Dynamic DPC enable 11 – Static and Dynamic DPC enable
Data (31:2)	:	N/A

3.3.15.4 HPC Enable

This register enables the HPC (Hot Pixel Correction).

Address	:	0x041C
Data (1:0)	:	00 – HPC disable 01 – Static HPC enable 10 – Dynamic HPC enable 11 – Static and Dynamic HPC enable
Data (31:2)	:	N/A

3.3.15.5 Dynamic DPC Threshold

This register sets the threshold for dynamic pixel correction

Address	:	0x042C
Data (11:0)	:	<value> - 0 to 4095 counts
Data (31:12)	:	N/A

3.3.15.6 Dynamic HPC Threshold

This register sets the threshold for dynamic pixel correction

Address	:	0x0430
Data (11:0)	:	<value> - 0 to 4095 counts
Data (31:12)	:	N/A

*Chapter***4**

CHEETAH Configurator for Camera Link

This chapter provides a quick reference to using the CHEETAH Configurator camera configuration utility for the Camera Link series of CHEETAH cameras.

4.1 OVERVIEW

Camera configuration utility software and CHEETAH Camera Configurator (CamConfig) are provided with each camera. After installing the program, the user can program the camera, change its settings and save the settings in a file or in the camera. The configuration utility includes an interactive help file, which will guide you through the camera setup.

4.2 DISCOVERY PROCEDURE

The Imperx camera configurator utility (CamConfig) provides an intelligent, automated method of 'discovering' and 'searching' all available UART components in your PC and allowing you to select the one connected to the CHEETAH camera. CamConfig expects the frame grabber's serial interface DLL `clserXXX.dll` file to be located in `C:\Windows\System32`. If the CamConfig software does not find your camera, it could be because your frame grabber stored the `clserXXX.dll` file in a different directory on your computer. You will need to locate the file and move it to `C:\Windows\System32`.

To search for the frame grabber's `clserXXX.dll` file:

1. In Windows File Explore, click the **C drive**.
2. In the search field type `clser*` and press **Enter**.
3. After finding the appropriate file, move it to `C:\Windows\System32`.

The CamConfig engine not only finds the CamLink DLL port but also looks for any available COM port installed on the PC as well. It will then communicate with each port (.DLL and COM) and attempt to query the attached camera. After finding an attached Imperx CHEETAH camera, CamConfig will read the 'camera type' information from the camera. The CHEETAH camera name will appear in the list box, which includes all DLLs, ports, and cameras discovered. The user can then select the DLL/port/camera of interest by highlighting the entry and clicking the OK button. Clicking on the Rescan Ports button causes the above discovery procedure to repeat. Note: the frame grabber has to be Camera Link v1.0 (or later) compliant.

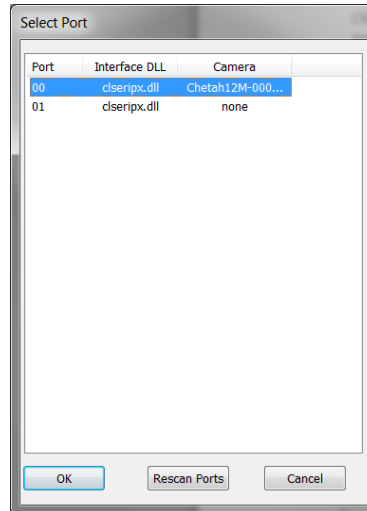

Figure 4.1: Discovery procedure – select port

4.3 GRAPHICAL USER INTERFACE

After having selected the desired camera, the main CHEETAH CamConfig dialog will appear –Figure 5.2. The Graphical User Interface (GUI) is very intuitive and self-explanatory. The basic features are:

1. **Compact Design** – small size saves space when user displays image and control at the same time.
2. **Real Time Data** – updates camera information in real time while camera is working. Gives quick and general information about camera configuration status.
3. **Dockable Windows** – all configuration windows (Gain, AOI, Trigger...) can be separated and “docked” in the main GUI with just one click.
4. **Configurable** – user can customize the main menu by selecting the sub windows and also memorize the last setting.

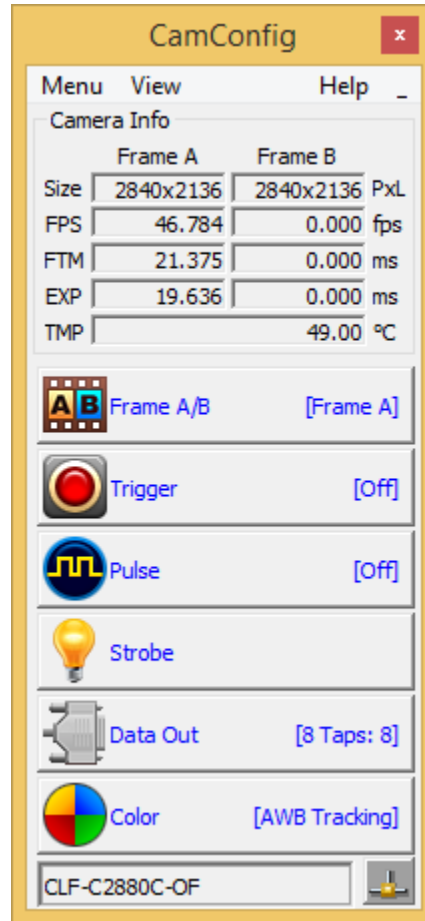

Figure 4.2: CamConfig GUI

The configuration utility includes an interactive help file, which will guide you through the GUI controls and camera settings. On the main window, the user can see useful camera information – Current Image Size (Size), Number of Frame per second (FPS), the Frame Time (FTM), Exposure Time (EXP) and Temperature of the CMOS sensor (TMP). Additional information can be obtained by clicking on the buttons shown in the CamConfig window, such as Video Amp, Trigger, etc. The bottom of the main utility window is camera name and status of Cam-link connection. If the connection between the camera and the computer is lost a red cross will appear above the connection icon.

4.4 MAIN GUI MENU

All panels in the CHEETAH CamConfig share the same general control options and menus for “Menu”, “View” and “Help” – Figure 4.3.

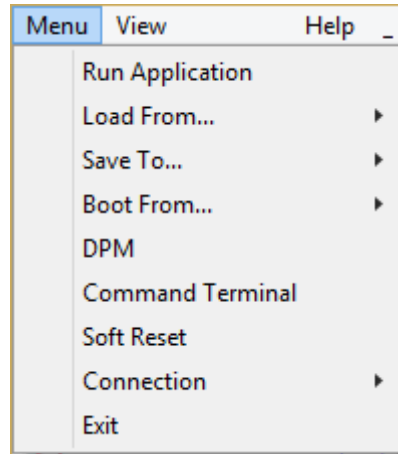

Figure 4.3: Main Menu

Run Application: Select and starts other executable file (Frame-Grabber application, etc....) that user normally uses. CamConfig will remember the path of last executable file that you used, so the next time when you start the application without having to type-in the location.

Load From: Loads the camera registers from a saved configuration space: File, Workspace, Factory Space, User Space #1 or User Space #2.

1. **File** – loads the camera registers from a saved configuration file
2. **Workspace** – updates the GUI with the current camera workspace settings
3. **Factory** – loads the camera registers with the original (factory) settings.
4. **User Space #1** – loads the camera registers with camera settings saved in the user space 1.
5. **User Space #2** – loads the camera registers with camera settings saved in the user space 2.

Save To: Saves the camera registers to File, User Space #1 or User Space #2. Factory Space is disabled for regular users and it is available only for manufacturing technicians.

1. **File** – saves the current camera settings to a configuration file
2. **Factory Space** – saves the current camera settings to the camera Factory space. This is restricted command and is disabled for regular users.
3. **User Space #1** – saves the current camera settings to the camera User space 1.

- User Space #2** – saves the current camera settings to the camera User space 2.

Boot: This menu selects the 'Boot From' source. Upon power up, the camera will load its registers from the selected 'Boot From' source: Factory, User #1 or User #2. CHEETAH camera will be release with 'Factory' Setting and user can save and boot camera with their own configurable features.

DPM: Defect Pixel Map – When selected, the DPM window will show defected pixels location. The defective pixel map is stored in the camera's non-volatile memory and read out when running bad pixel correction – Figure 4.4. Defected pixels are categorized as:

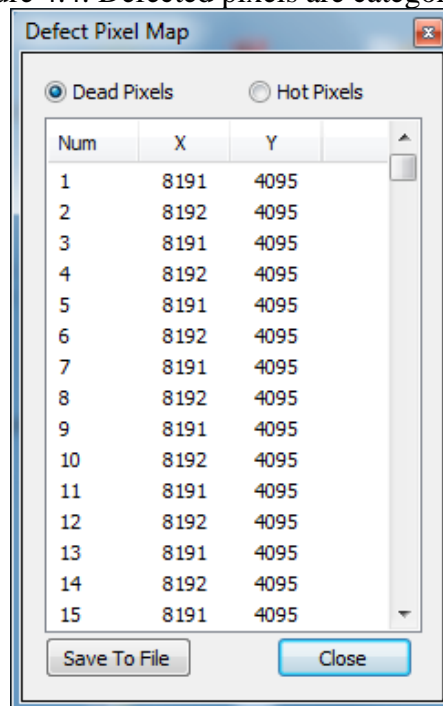

Figure 4.4: Defective pixel map

- Dead Pixels** – pixels with sensitivity that deviates more than 15% due to fluctuations in the CMOS manufacturing process.
- Hot Pixels** – pixels that during normal camera operation are normal, but in long integration modes (programmable frame time) behave as high-intensity bright pixels.

Terminal: The user can display two panels: Command Terminal and a download utility.

- 1. Command Terminal** – shows information about all the commands sent to or received from the camera. User can type in CHEETAH command directly in the text box provided – Figure 5.5. All commands must start with **0x** followed by **ADDRESS** and **DATA**, without spaces – refer to chapter 4 for more information. The “Disable Polling” check box will turn on/off the polling commands (such as Frame Time, Exposure time, Frame Rate and Sensor Temperature) in the dialog windows. The user can change the polling time by entering the desired number in the window. If for some reason the camera returns an error, when command was sent to the camera, the GUI will respond with a pop-up window displaying an error message. The user has option to disable the error checking by enabling the “Disable Error Checking” box.

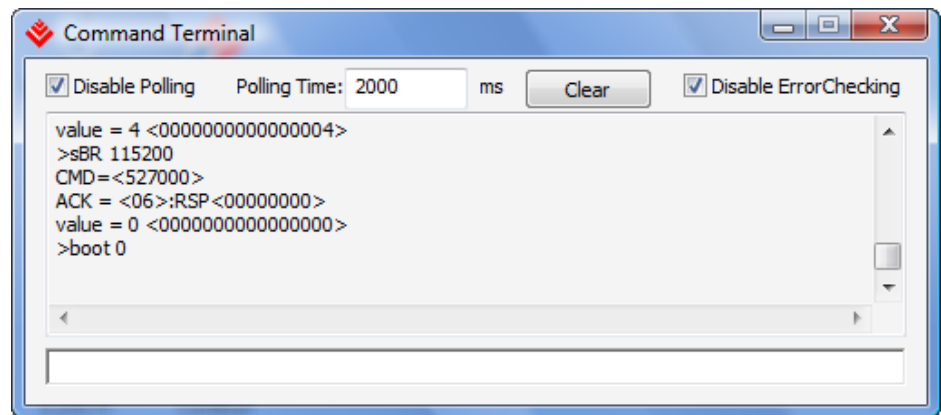

Figure 4.5: Command terminal

- 2. Cheetah Download Utility (BUM)** – One of the great features about the Cheetah is the separate Cheetah Download Manager. This separates the powerful features of uploading LUTs, Firmware, Defective Pixel Map and Hot Pixel Map.

Soft Reset

Re-initializes the camera similar to cycling power to the camera.

Connection:

The user can select the connection type between the camera and the computer:

- 1. Switch Port** – If checked, “Select Port” window will popup. The user can select new CamLink port, which connect to current camera.

2. Set Baud Rate – the user can set the communication baud rate: 9600, 19200, 38400, 57600 or 115200 (default value).

Exit: Terminates the application.

4.5 VIEW GUI WINDOWS

The 'View' menu allows the user to select which camera parameter window to be displayed on the main CamConfig GUI window – Figure 4.6.

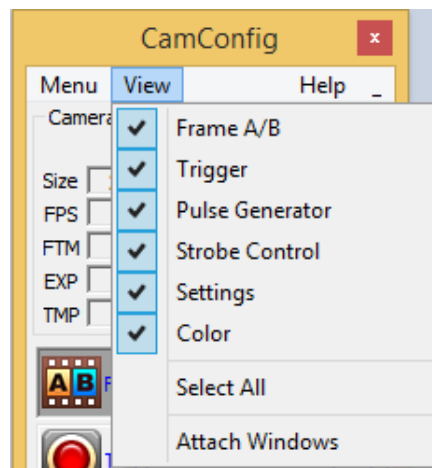

Figure 4.6: View Menu

Frame A/B: Controls the exposure, AOI, camera analog, digital gain, black level correction, Averaging, Subsampling and Wide Dynamic Range modes for each acquisition frame (A&B). The user has several options controlling switching between Frame A and Frame B.

Trigger: Controls the camera triggering features.

Pulse Generator: Enables and controls the internal pulse generator which can be used to generate trigger or output signals.

Strobe Control: Enables and controls the camera strobe signals.

Settings: Sets the output data format, enables Look Up Tables, H&V Mirror, DPC, HPC and test patterns

Color: Sets the white balance mode. Displays WBC values.

Select All: Enables all camera parameter windows.

Attach Windows: Attaches all camera parameter windows to the main GUI window.

4.6 MENU HELP

The main “Help” menu is shown on Figure 4.7

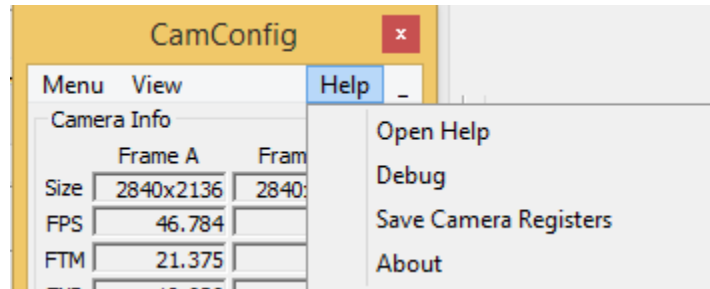

Figure 4.7: Help menu

Open Help: Opens an interactive help file.

Debug: Puts the GUI in a debug mode for test purposes and troubleshooting.

Save Camera Reg Saves the camera registers

About: Provides information about application version and important camera parameters such as Firmware revision, Assembly Part Number, etc. – Figure 4.8.

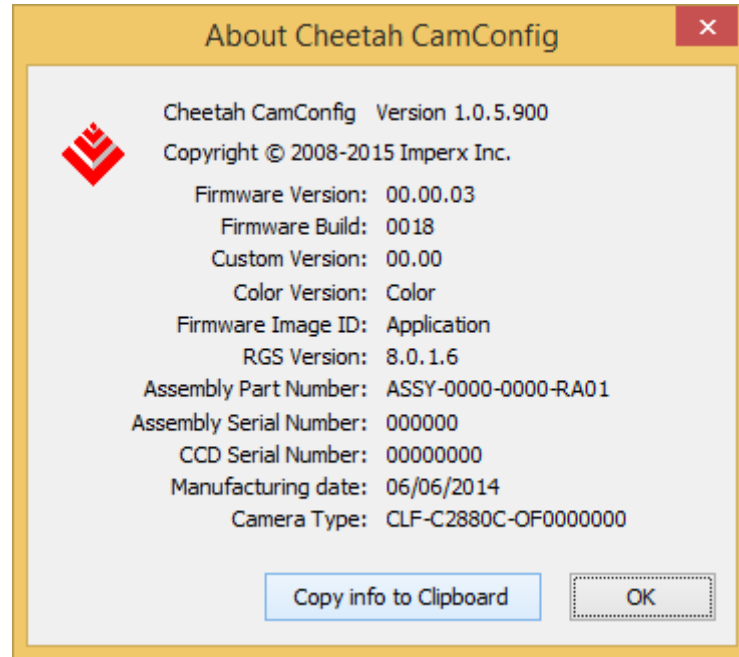

Figure 4.8: About CamConfig.

4.7 PARAMETER WINDOWS

CHEETAH Cameras have many features that can easily be programmed using the CHEETAH graphical user interface (GUI) or via simple register commands using the Command Terminal. The main parameter windows are described below.

4.7.1 Dual Video (Frame A / Frame B) Window

4.7.1.1 Dual Video Controls

Frame A / B window allows the user to set up two independent acquisition setups (Frames) and the conditions under which the camera switches between these two independent camera configurations.

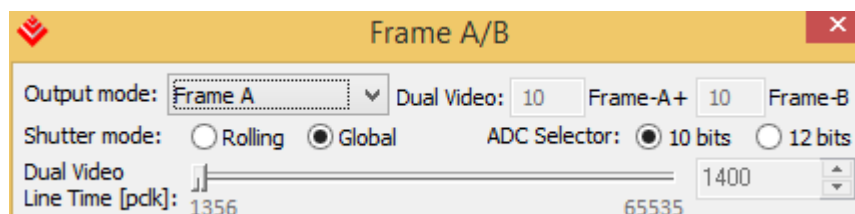

Figure 4.9: Frame A/B Options Menu

- Output Mode:**
- Frame A:** outputs video according to the Frame A settings.
 - Frame B:** outputs video according to the Frame B settings.
 - Dual Video:** the camera outputs 'M' Frame As followed by 'N' Frame Bs then repeats this sequence. 'M' and 'N' are values between 1 and 256. In the above graphic, Dual Video is selected and M is set to 3 and N is set to 1. If trigger is enabled, the camera waits for trigger, then outputs 'M' Frame As followed by 'N' Frame Bs and then awaits the next trigger.
 - Dual Video Trigger:** the camera outputs Frame As continuously. Upon receipt of trigger, the camera outputs 'N' Frame Bs and then returns to outputting Frame A's.
- Shutter Mode** Selects Shutter mode. Global shutter for objects in high speed motion or rolling shutter for best dynamic range and lowest possible noise floor.
- ADC Selector:** Selects image sensor digitization level. 12-bit digitization requires longer settling time and impacts maximum camera frame rate. 10-bit digitization provides higher maximum frame rates.
- DV Line Time** In Dual Video mode, line time controls for Frame A and Frame B are disabled. The dual video line time control sets the line time for both Frame A and Frame B captures.

4.7.1.2 Exposure Controls

This window controls the camera exposure, line and frame time.

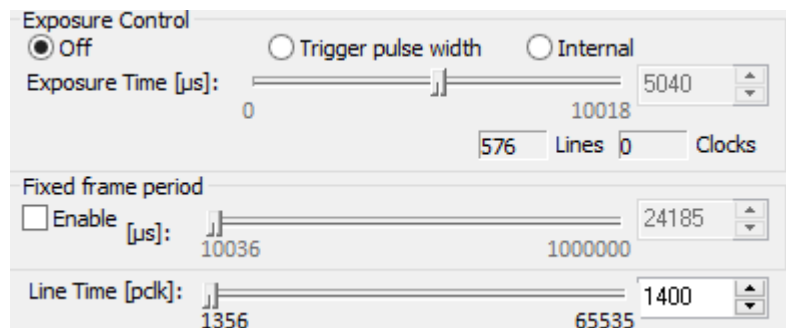

Figure 4.10: Exposure control window

4.7.1.2.1 Exposure Control (Texp):

Sets the camera exposure period with three options.

Off – no exposure control. The camera free runs and the exposure time equals the frame time.

Trigger Pulse Width – the pulse width (duration) determines the exposure. Trigger must be enabled.

Internal – internal camera registers control the exposure. Exposure time slider – sets the actual camera exposure in microseconds. The minimum exposure time adjusts accordingly, based on the camera mode of operation. The slider can only be used when “Internal” mode is enabled.

4.7.1.2.2 Fixed Frame Period

These controls allow the user to control the frame rate and the line rates of the camera. Since the camera outputs data at a very high rate, the line time controls are used to match the camera output rate to the interface bandwidth. The fixed frame period control should be enabled to achieve the desired output frame rate.

Fixed Frame Period – can be enabled or disabled. If enabled, the frame time can be set using the slider bar (in microseconds) or using the inputting the desired frame time in the box to the right of the slider.

Line Time - The camera will automatically compute the minimum line time necessary to match the camera output data rate to the interface data rate. As a general rule, the user should always set the line rate to the minimum value.

4.7.1.3 Area of Interest (AOI)

AOI is used to select the area of the image sensor which will be output to the user. The user chose to output the entire image sensor field of view or any region within this field of view.

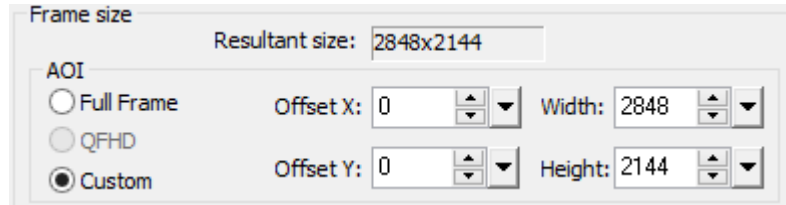

Figure 4.11: AOI Functions

Full Frame: This is a pre-programmed AOI providing the full resolution of the camera.

QFHD: This is a pre-programmed AOI providing a Quad Full HD (3840 x 2160) centered within the field of view **available only on the C4030 version**

Custom: The user can enter the desired area of interest by setting the active window size (Width, Height) and offset (X, Y). Image location (1, 1) is top left corner. The user can set the desired window size by inputting the numbers directly or use the scroll controls. Horizontal offset value should be multiple of 8, horizontal offset value should be multiple of 2

4.7.1.4 Subsampling and Averaging

Subsampling and Averaging functions are active within the defined AOI and is used to reduce the output resolution while maintaining the desired field of view. See Figure 4.12.

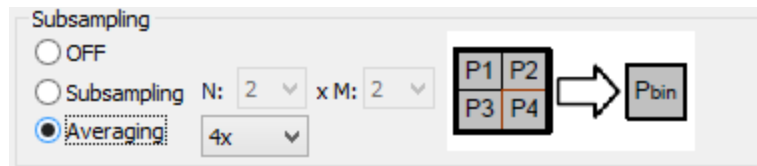

Figure 4.12: Subsampling Functions

Off: Both subsampling and averaging are disabled.

Subsampling: Decimates the output image within the defined AOI by outputting 'N' out of 'M' pixels within each row and 'N' out of 'M' rows within each frame. The 'N' pixels and rows are adjacent to one another. In all cases, 'N' must be less than 'M'. If 'N' is greater than or equal to 'M', subsampling is disabled.

Note: For color applications (Bayer Output), N and M values must be multiples of 2.

Averaging: The Cheetah offers a four-into-one (4:1) and nine-into-one (9:1) averaging. In the case of 4:1 averaging, four pixels are summed together and the result divided by 4. In the case of 9:1 averaging 9 pixels are summed and the result divided by nine. Averaging can be used with monochrome or color image sensors. In the case of color, the Bayer pattern will be preserved.

4.7.1.5 Video Amplifier

Video Amplifier allows the user to adjust the Analog and Digital Gains and black level. Manual entry and sliders are available for adjusting the individual parameters – Figure 4.13.

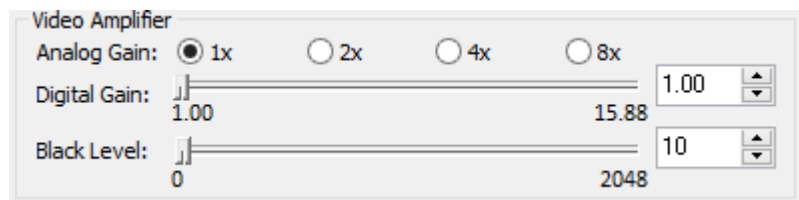

Figure 4.13: Video Amp parameter window

Analog Gain: The user can set the desired analog gain using radio buttons. For digitization levels of 8 or 10-bits, analog gain levels of 1x, 2x, 4x and 8x can be selected. For 12-bit digitization level, analog gain levels of 1x, 2x and 4x are supported. Analog gain should always be applied before digital gain.

Digital Gain: The user can set the digital gain from 1 to 15.88x with 128 individual steps. (Step size varies with gain setting with finer steps at lower gain settings)

Black Level: The digital offset (0 to 8192, 1 step increment) via the slider or by entering the desired value. Digital offset is applied after gain.

4.7.1.6 Wide Dynamic Range (WDR)

Wide Dynamic Range mode is available in global shutter mode only and allows the user to compress bright regions of the image into the available

output range. The camera allows the user to select from three user defined exposure periods depending upon the brightness of each individual pixel. See Figure 4.14.

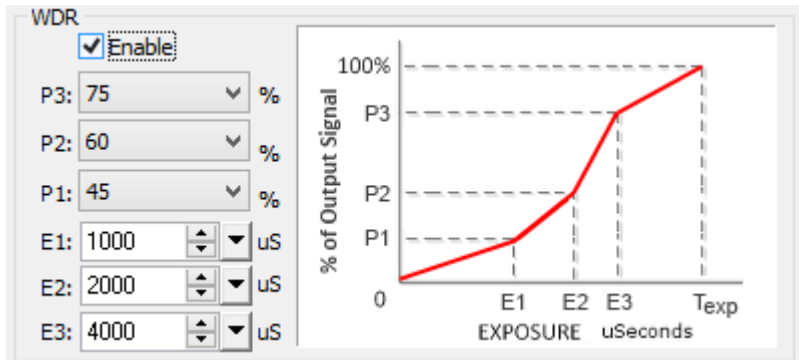

Figure 4.14: Wide Dynamic Range Controls

WDR: Wide Dynamic Range (WDR) [also Extended Dynamic Range] can be enabled or disabled using the Enable check box.

The overall exposure period (T_{exp}) is set using the Exposure control slider. (See Section 4.7.1.2 Exposure Controls) Pixels in the dark regions of the image area will collect charge through-out the entire exposure period.

E1: Exposure period for 'Bright' pixels E1 can be set with the slider or input directly. E1 must be some fraction of the overall exposure period as defined by the Exposure setting. Bright pixels are exposed for $T_{exp} - E1$. See section 4.7.1.2 Exposure Controls.

E2: Exposure Period for Very Bright pixels. Can be set with slider or input directly. Very Bright pixel exposure is $T_{exp} - E2$. E2 must be some fraction of T_{exp} and must be greater than E1.

E3: Exposure Period for Ultra Bright pixels. Can be set with slider or input directly. Ultra-Bright pixel exposure is $T_{exp} - E3$. E3 must be some fraction T_{exp} and greater than of E2.

P1: Percentage of camera output assigned to Dark pixels. Select from 15% to 100% in 5% steps. Normal setting is 30% to 70%. The Dark pixel information is contained from 0% output level to the P1 setting.

P2: Percentage of camera output allocated to Bright pixels. Select from 15% to 100% in 5% steps. P2 must be greater than P1. The Bright pixel information is contained between the P1 to P2 output levels. To disable the E2 and E3 exposures, set P2 and P3 to 100%.

P3: Percentage of camera output assigned to Very Bright pixels. Select from 15% to 100% in 5% steps. The Very Bright pixel information is contained between the P2 to P3 output levels. To disable the E3 exposure, set P3 to 100%.

The “Ultra-Bright” pixel information is contained between the P3 level and 100% of the output.

Notes:

- 1) A good set of initial settings as follows:
 - E1: 90% or 95% of the overall exposure time
 - P1: 50%
 - P2, P3 both set to 100%.

4.7.2 Trigger Inputs

The Trigger Tab is used to set the camera trigger inputs and trigger settings – Figure 5.15. The user can select from one of 6 input sources and set the active trigger edge to rising or falling with optional signal debouncing.

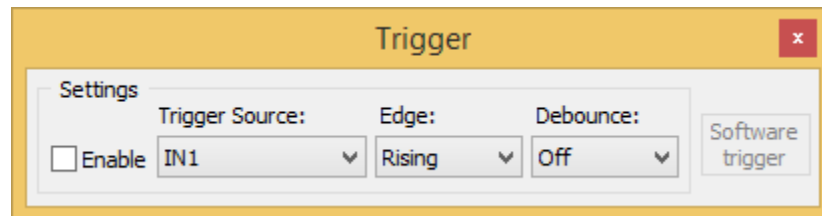

Figure 4.15: Trigger parameter window

Enable – Enabling the trigger function allows the user to control either the camera Frame A/B exposure period or control the dual video mode switching.

Trigger Source – selects the active triggering input signal from one of six sources.

In1 –External Camera Input 1

In2 – External Camera Input 2

CC1 – Camera Link Control 1

CC2 – Camera Link Control 2

Software – Software trigger button command that can be sent by “Software trigger” button.

Pulse Gen – the internal pulse generator produces the trigger signal.

Edge – the user can select the active triggering edge:

Rising – the rising edge is used for triggering.

Falling – the falling edge is used for triggering.

Debounce – the trigger inputs are de-bounced to prevent multiple triggering from ringing triggering pulses. The user has eight choices of de-bounce interval:

Off – No de-bounce

10.0 us – 10 microseconds de-bounce interval.

50.0 us – 50 microseconds de-bounce interval.

100.0 us – 100 microseconds de-bounce interval (default).

500.0 us – 500 microseconds de-bounce interval.

1.0 ms – 1 milliseconds de-bounce interval.

5.0 ms – 5 milliseconds de-bounce interval.

10.0 ms – 10 milliseconds de-bounce interval.

Software Trigger – this button only becomes active when the Trigger source selected is ‘Software’. Pressing the Software Trigger button triggers the camera one-time. This can be useful in debugging operation.

4.7.3 Pulse Generator

In this window, the user can configure the parameters of the Internal Pulse Generator – Figure 4.16.

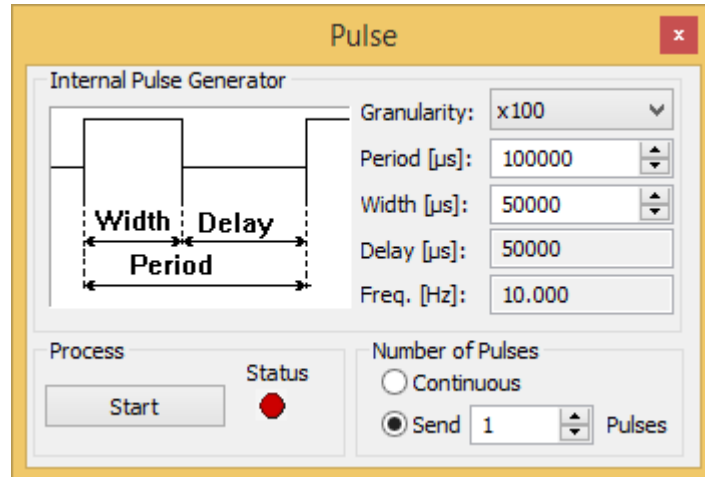

Figure 4.16: Pulse generator window

Granularity: Sets the granularity for the internal counters. Granularity can be set to 1x, 10x, 100x or 1000x.

Period: Sets the pulse period in microseconds.

Width: Sets the pulse width in microseconds.

of Pulses: Sets the number of pulses generated. Two modes are available:

1. Continuous – provides a continuous operation. To stop the process, you have to press the “Stop” button.
2. Send # Pulses – the user can set only a discrete number of pulses ranging (1 to 65500) to be generated. To stop the process, you have to press the “Stop” button. Otherwise, the process stops automatically after the last pulse is sent.

Process: **Start** – starts and stops the process of Internal Pulse Generator. When the process is in progress, the ‘Start’ button becomes a ‘Stop’ button.

Status – provides the status of the process:
 Red – the process is on hold,
 Green – the process is working.

4.7.4 Strobe Control And Output Mapping

This window sets the camera strobe signals. Two independently controlled strobe signals are supported – Figure 4.17.

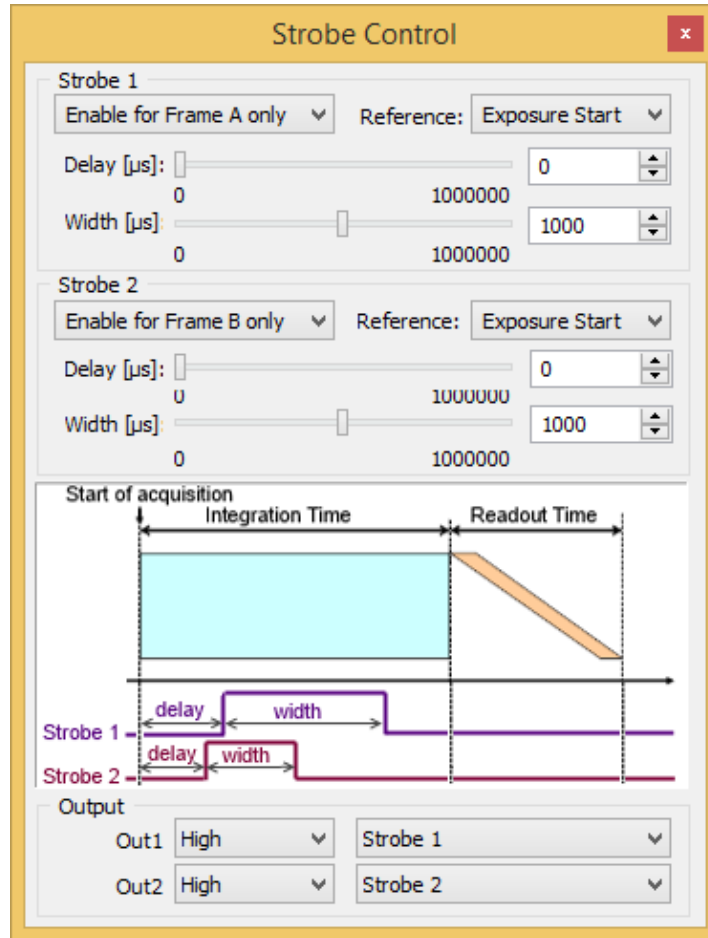

Figure 4.17: Strobe Control window

Strobe 1 Mode: Sets the Strobe 1 mode of operation. The strobe can be disabled or enabled. When enabled, the strobe can be referenced to Frame A, referenced to Frame B or referenced to both Frame A and Frame B.

Strobe 2 Mode: Sets the Strobe 2 mode of operation. The strobe can be disabled or enabled. When enabled, the strobe can be referenced to Frame A, referenced to Frame B or referenced to both Frame A and Frame B.

Reference: Sets the reference for the Strobe pulse. Options are either the beginning of the Frame “X” exposure period or the beginning of the Frame “X” readout period.

Delay/Width: Sets the duration and delay of the strobe sent to the camera output. The user can set the strobe pulse width and the delay from 0 to 1,000,000 us.

OUTPUT MAPPING

- Out1** External Output 1 can be mapped to the following:
No Mapping, Trigger Input (Mirror), Pulse Generator, Strobe 1 or Strobe 2
- Out1 Polarity:** External Output 1 polarity can be changed to be active High or Low.
- Out2** External Output 2 can be mapped to the following:
No Mapping, Trigger Input (Mirror), Pulse Generator, Strobe 1 or Strobe 2
- Out2 Polarity:** External Output 2 polarity can be changed to be active High or Low.

4.7.5 Data Output

Data Output window provides full control of the camera digital data output – Figure 4.18.

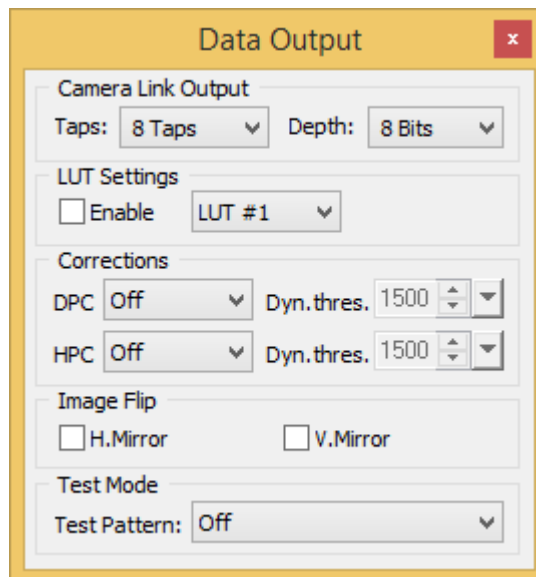

Figure 4.18: Data output window

Camera Link Settings: Sets the data format and camera speed. Refer to Chapter 2 for more information.

Taps – sets the number of image taps used in the current configuration. These are Camera Link Output Taps. In some cameras, the tap selection is not available:

A: 1-Taps: Camera Link (CL) Base mode. Single – only one CL tap is used. (24-bits)

B: 2-Taps: Camera Link Base (24-bits)

C: 4-Taps: Camera Link (48-bits)

D: 8-Taps: Camera Link Full (72-bits)

E: 10-Taps: Camera Link Deca (80-bits)

Depth – sets the output data bit depth, i.e. the number of output bits per pixel and mapped to the camera link output. Options are 8, 10 or 12 bits.

LUT Settings: **Enable:** enables the usage of the selected Look-Up Table (LUT).

LUT Select – selects which of the two supported LUTs will be used. By default, LUT #1 is factory programmed with standard Gamma of 0.45. LUT #1 and LUT #2 can be reprogrammed by the user.

Corrections: **DPC** – enables Defective Pixel Correction (DPC). Each camera comes with a built-in Defective Pixel Map (DPM) to correct for defective pixels. The user can upload a custom DPM.

HPC – enables Hot Pixel Correction (HPC). Each camera comes with a built-in Hot Pixel Map (HPM) to correct for hot pixels. The user can upload a custom HPM

Image Flip: **H. Mirror:** Mirrors the Horizontal output video when checked 'On'.

V. Mirror: Mirrors the Vertical output video when checked 'On'

Test Mode: **Test Patterns** – the camera can output eight test patterns:

1. Off – test mode is off.
2. H Ramp – displays a stationary horizontal ramp image.
3. V Ramp – displays a stationary vertical ramp image.
4. H Ramp move – displays a moving horizontal ramp image.
5. V Ramp move – displays a moving vertical ramp image.
6. Crosshair – superimposes a cross, located in the center of the CMOS images.

4.7.6 Color

This window sets the corrections for the primary R G B colors. In addition, this window sets the White balance mode and displays the calculated white balance coefficients – Figure 4.19. This window is disabled for monochrome cameras.

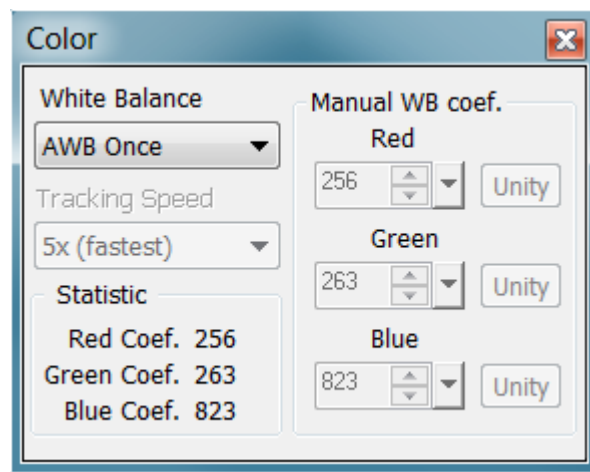

Figure 4.19: Color window

White Balance: Sets the White balance mode of operation.

1. “Off” – No white balance is performed.
2. “AWB Once” – the camera analyzes only one image frame, calculates only one set correction coefficients, and all subsequent frames are corrected with this set of coefficients.
3. “AWB Tracking” – the camera analyzes every frame, a set of correction coefficients are derived for each frame and applied to the next frame.
4. “Manual” – the camera uses the correction coefficients as entered from the user.

Manual WBC: The user enters manually the white balance coefficients for each color. The range is from 0 to 255 (255 is equal to 1.0x). The user has option to set all coefficients to “Zero”.

Tracking Speed: For Auto-White Balance (AWB), the user has the option of selecting from five update rates. When 1x is selected, the AWB algorithm responds slowly to any changes in the scene illumination whereas 5x tracking provides most responsiveness.

Manual WB: The user can set individually the desired digital gain for each primary color R G B (1.0x to 4.0x, 0.001x increment) via the arrows or by entering the desired value. The user has option to set all gains to “Unity” (1.0x)

The graphic for Chapter 5 features the word "Chapter" in a white, italicized, sans-serif font with a black outline, positioned to the left of a large red diamond shape. Inside the diamond, the number "5" is written in a white, bold, sans-serif font with a black outline. The diamond itself is composed of several horizontal and vertical stripes in red and white, creating a 3D effect.



Cheetah Warranty and Support



5.1 ORDERING INFORMATION

Cheetah KAC Camera Ordering Codes			Sample Code: CLF-C4080M-OF000			
Interface: CLF	Camera Number: C4080	Sensor type: M	Sensor Manufacture:)	Lens Mount: F	Filter Option: 0	Misc: 00
CLF - Camera Link Full	C2880 - 2832 x 2128	M- monochrome	O - On Semiconductor	C - C Mount (C2880 only)	0 - none	reserved
	C4080 - 4000 x 3000	C - color		F - F Mount	2 - Color w/out filters (C & F-mount)	
				B - Birger	3 - Color w/ front CG filter (C-mount)	
					4 - Color w/ front CG filter (F-Mount)	
					5 - Mono with Front IR filter (C-mount)	
					6 - Mono with Front CG filter (C-mount)	
					7 - Mono with Front CG filter (F-Mount)	
					8 - Mono with Front IR filter - (F-Mount)	
					A - Mono with Rear CG filter (F-Mount)	
					B- Mono With Rear IR filter (F-Mount)	
					C- Color with rear CG filter (F-Mount)	
					D - Color with rear IR filter (F-Mount)	

Note: Power Supply is sold separately

NOTE: For any other custom camera configurations, please contact Imperx, Inc.

5.2 TECHNICAL SUPPORT

Each camera is fully tested before shipping. If for some reason the camera is not operational after power up please check the following:

1. Check the power supply and all I/O cables. Make sure that all the connectors are firmly attached.
2. Check the status LED and verify that it is steady ON, if not – refer to the LED section.
3. Enable the test mode and verify that the communication between the frame grabber and the camera is established. If the test pattern is not present, power off the camera, check all the cabling, frame grabber settings and computer status.
4. If you still have problems with the camera operation, please contact technical support at:

Email: techsupport@imperx.com
Toll Free 1 (866) 849-1662 or (+1) 561-989-0006
Fax: (+1) 561-989-0045
Visit our Web Site: www.imperx.com

5.3 WARRANTY

Imperx warrants performance of its products and related software to the specifications applicable at the time of sale in accordance with Imperx's standard warranty, which is 2 (two) years parts and labor. **FOR GLASSLESS CAMERAS THE CMOS IS NOT COVERED BY THE WARRANTY.**

Do not open the housing of the camera. Warranty voids if the housing has been open or tampered.

IMPORTANT NOTICE

This camera has been tested and complies with the limits of Class A digital device, pursuant to part 15 of the FCC rules.

Copyright © 2013 Imperx Inc. All rights reserved. All information provided in this manual is believed to be accurate and reliable. No responsibility is assumed by Imperx for its use. Imperx reserves the right to make changes to this information without notice. Redistribution of this manual in whole or in part, by any means, is prohibited without obtaining prior permission from Imperx. Imperx reserves the right to make changes to its products or to discontinue any product or service without notice, and advises its customers to obtain the latest version of relevant information to verify, before placing orders, that the information being relied on is current.

IMPERX PRODUCTS ARE NOT DESIGNED, INTENDED, AUTHORIZED, OR WARRANTED TO BE SUITABLE FOR USE IN LIFE-SUPPORT APPLICATIONS, DEVICES OR SYSTEMS OR OTHER CRITICAL APPLICATIONS, WHERE MALFUNCTION OF THESE PRODUCTS CAN REASONABLY BE EXPECTED TO RESULT IN PERSONAL INJURY. IMPERX CUSTOMERS USING OR SELLING THESE PRODUCTS FOR USE IN SUCH APPLICATIONS DO SO AT THEIR OWN RISK AND AGREE TO FULLY INDEMNIFY IMPERX FOR ANY DAMAGES RESULTING FROM SUCH IMPROPER USE OR SALE.

*Appendix***A**

Camera Configuration Reference

This appendix provides a quick reference to the camera configuration workspace registers.

A.0 ABBREVIATIONS

RW – read/write, **RO** – read only, **WO** – write only

MAX_HRZ_SIZE, **MIN_HRZ_SIZE** – Max. and Min. horizontal image size – camera dependent

MAX_VER_SIZE, **MIN_VER_SIZE** – Max. and Min. vertical image size – camera dependent

LIN_TIM_MIN – Minimum Line time

FRM_TIM_MIN – Minimum Frame time

A.1 SAVING AND RESTORING REGISTERS

Address	Register Name	Type	Usage	MIN Value	MAX Value
0x6000	Boot From	RW	00 - Factory, 01 - User 1, 10 - User 2	0x00000000	0x00000002
0x601C	Soft Reset	WO	Command	0xDEDBEEF	0xDEDBEEF
0x6060	Load From Factory	WO	Command	0x00000000	
0x6064	Load From User1	WO	Command	0x00000000	
0x6068	Load From User2	WO	Command	0x00000000	
0x6074	Save to User1	WO	Command	0x00000000	
0x6078	Save to User2	WO	Command	0x00000000	

A.2 CAMERA INFORMATION REGISTERS

Address	Register Name	Type	Value
0x6004	Firmware Revision	RO	<Firmware Revision>
0x6008	FPGA & EPCS & Customer ID	RO	<Image_ID & Sensor Type & FWare Rev>
0x600C	Test Register	RW	0x76543210
0x6010	Camera Temperature	RO	<TEMPERATURE_STATUS>
0x6020	Pixel Clock Rate	RO	In MHZ
0x6080	Frame A Exposure Time	RO	<FRA_EXP_TIM>
0x6084	Frame A Frame Time	RO	<FRA_FRM_TIM>
0x6088	Frame B Exposure Time	RO	<FRB_EXP_TIM>
0x608C	Frame B Frame Time	RO	<FRB_FRM_TIM>
0x6090	Frame A Horizontal Size	RO	<FRA_HOR_SIZE >
0x6094	Frame A Vertical Size	RO	<FRA_VER_SIZE>
0x6098	Frame B Horizontal Size	RO	<FRB_HOR_SIZE>
0x609C	Frame B Vertical Size	RO	<FRB_VER_SIZE>
0x60A4	Horizontal Size (Max)	RO	<HOR_SIZE_MAX>
0x60A8	Vertical Size (Max)	RO	<VER_SIZE_MAX>
0x60AC	Camera Attributes (Tri-scan)	RO	Bit 8:Tri-scan mode, (7-0): Reserved
0x60B0	Frame A Line Time (Min)	RO	<FRA_LT_MIN>
0x60B4	Frame B Line Time (Min)	RO	<FRB_LT_MIN>

A.3 FRAME A REGISTERS (Stored in FLASH)

Address	Register Name	Type	Usage	MIN Value	MAX Value
0x0000	Frame A – AOI Vertical Offset (Y1)	RW	Offset Value d(11:0). multiple of 2	0x00000000	MAX_VER_SIZE-2
0x0004	Frame A – AOI Height (H1)	RW	Height Value D(11:0) multiple of 2	0x00000000	MAX_VER_SIZE
0x0008	Frame A – AOI Horizontal Offset (X1)	RW	Offset Value d(11:0) multiple of 2	0x00000000	MAX_HOR_SIZE-2
0x000C	Frame A – AOI Width (W1)	RW	Width Value d(11:0) multiple of 2	0x00000000	MAX_HOR_SIZE
0x0050	Frame A – Black Level	RW	Black Offset Value	0x00000000	0x000007FF
0x0700	Frame A – Fixed Frame Period Enable	RW	00 – Disable, 01 – Enable	0x00000000	0x00000001
0x0704	Frame A – Fixed Period (in line times)	RW	<# lines>	0x00000000	0x0000FFFF
0x0710	Frame A – Line Time	RW	Line Time (pixel clocks)	0x00000000	0x00000001
0x0720	Frame A – Exposure Control mode	RW	00- Off, 01 – trigger Pulse width 10 – Internal Timer	0x00000000	0x00000002
0x0728	Frame A Integration Lines	RW	Exposure Value (in Lines)	0x00000000	0x00000001
0x072C	Frame A Integration Clocks	RW	Exposure Value Pixel Clocks)	0x00000001	0x00000001
0x073C	Frame A Decimation Mode	RW	00 – off, 01 – Subsample enable 02 – Averaging Mode	0x00000001	0x00000002
0x0740	Frame A Subsampling Parameter N	RW	# Contiguous Pixels to Keep (mult of 2)	0x00000001	0x0000000F
0x0744	Frame A Subsampling Parameter M	RW	# Pixels to skip	0x00000001	0x0000000F
0x0748	Frame A Analog Gain	RW	<Analog Gain Value>	0x00000001	0x0000007F
0x074C	Frame A Digital Gain Fine	RW	<Dig. Gain Fine Value>	0x00000001	0x0000003F
0x0750	Frame A Digital Gain Coarse	RW	<Dig. Gain Coarse Value)	0x00000001	0x00000003
0x0778	Frame A Pixel Averaging	RW	00 – 4:1, 01 – 9:1	0x00000001	0x00000001

A.4 FRAME A WDR REGISTERS

Address	Register Name	Type	Usage	MIN Value	MAX Value
0x0600	Frame A WDR Enable	RW	00 – disable 01 –enable	0x00000000	0x00000001
0x0604	Frame A WDR P1 (Dark Pixel Allocation of Output Range)	RW	0000 – 100%, 0001 – 90% 0010 – 80%, 0011 – 75% 0100 – 70%, 0101 – 65% 0110 – 60%, 0111 – 55% 1000 – 50%, 1001 – 45% 1010 – 40%, 1011 – 35% 1100 – 30%, 1101 – 25% 1110 – 20%, 1111 – 15%	0x00000000	0x0000000F
0x0608	Frame A WDR P2 (Bright Pixel Allocation of Output Range)	RW	0000 – 100%, 0001 – 90% 0010 – 80%, 0011 – 75% 0100 – 70%, 0101 – 65% 0110 – 60%, 0111 – 55% 1000 – 50%, 1001 – 45% 1010 – 40%, 1011 – 35% 1100 – 30%, 1101 – 25% 1110 – 20%, 1111 – 15%	0x00000000	0x0000000F
0x060C	Frame A WDR P3 (Set to 0000)	RW	0000 – 100%, 0001 – 90% 0010 – 80%, 0011 – 75% 0100 – 70%, 0101 – 65% 0110 – 60%, 0111 – 55% 1000 – 50%, 1001 – 45% 1010 – 40%, 1011 – 35% 1100 – 30%, 1101 – 25% 1110 – 20%, 1111 – 15%	0x00000000	0x0000000F
0x0610	Frame A WDR Bright Pixel Exposure (E1)	RW	<Bright Pixel Exposure Time (us)>	0x00000000	0x000FFFFFFF
0x0614	Frame A WDR Very-bright Pixel Exposure (E2)	RW	<Very-Bright Pixel Exposure Time (us)>	0x00000000	0x000FFFFFFF
0x0660	Frame A WDR Ultra-bright Pixel Exposure (E3)	RW	<Ultra-Bright Pixel Exposure Time (us)>	0x00000000	0x000FFFFFFF

A.5 FRAME B REGISTERS (Stored in FLASH)

Address	Register Name	Type	Usage	MIN Value	MAX Value
0x0100	Frame B – AOI Vertical Offset (Y1)	RW	Offset Value d(11:0). multiple of 2	0x00000000	MAX_VER_SIZE-2
0x0104	Frame B– AOI Height (H1)	RW	Height Value D(11:0) multiple of 2	0x00000000	MAX_VER_SIZE
0x0108	Frame B – AOI Horizontal Offset (X1)	RW	Offset Value d(11:0) multiple of 2	0x00000000	MAX_HOR_SIZE-2
0x010C	Frame B – AOI Width (W1)	RW	Width Value d(11:0) multiple of 2	0x00000000	MAX_HOR_SIZE
0x0150	Frame B – Black Level	RW	Black Offset Value	0x00000000	0x000007FF
0x0708	Frame B – Fixed Frame Period Enable	RW	00 – disable 01 – Enable	0x00000000	0x00000001
0x070C	Frame B – Fixed Frame Period (in line times)	RW	<# Lines>	0x00000000	0x00000001
0x0714	Frame B – Line Time	RW	Line Time (pixel clocks)	0x00000000	0x00000001
0x0724	Frame B – Exposure Control	RW	00- Off, 01 – trigger Pulse width 10 – Internal Timer	0x00000000	0x00000002
0x0730	Frame B Integration Lines	RW	Exposure Value (in Lines)	0x00000000	0x00000001
0x0734	Frame B Integration Clocks	RW	Exposure Value Pixel Clocks)	0x00000001	0x00000001
0x0754	Frame B Decimation Mode	RW	00 – off, 01 – Subsample enable 02 – Averaging Mode	0x00000001	0x00000002
0x0758	Frame B Subsampling Parameter N	RW	# Contiguous Pixels to Keep (mult of 2)	0x00000001	0x0000000F
0x075C	Frame B Subsampling Parameter M	RW	# Pixels to skip	0x00000001	0x0000000F
0x0760	Frame B Analog Gain	RW	<Analog Gain Value>	0x00000001	0x0000007F
0x0764	Frame B Digital Gain Fine	RW	<Dig. Gain Fine Value>	0x00000001	0x0000003F
0x0768	Frame B Digital Gain Coarse	RW	<Dig. Gain Coarse Value)	0x00000001	0x00000003
0x077C	Frame B Pixel Averaging	RW	00 – 4:1, 01 – 9:1	0x00000001	0x00000001

A.6 FRAME B WDR REGISTERS

Address	Register Name	Type	Usage	MIN Value	MAX Value
0x0618	Frame B WDR Enable	RW	00 – disable , 01 –enable	0x00000000	0x00000001
0x061C	Frame B WDR P1 (Dark Pixel Output Range Allocation)	RW	0000 – 100%, 0001 – 90% 0010 – 80%, 0011 – 75% 0100 – 70%, 0101 – 65% 0110 – 60%, 0111 – 55% 1000 – 50%, 1001 – 45% 1010 – 40%, 1011 – 35% 1100 – 30%, 1101 – 25% 1110 – 20%, 1111 – 15%	0x00000000	0x0000000F
0x0620	Frame B WDR P2 (Bright Pixel Allocation of Output Range)	RW	0000 – 100%, 0001 – 90% 0010 – 80%, 0011 – 75% 0100 – 70%, 0101 – 65% 0110 – 60%, 0111 – 55% 1000 – 50%, 1001 – 45% 1010 – 40%, 1011 – 35% 1100 – 30%, 1101 – 25% 1110 – 20%, 1111 – 15%	0x00000000	MAX_HRZ_SIZE - 1
0x0624	Frame B WDR P3 (Set to 0000)	RW	0000 – 100%, 0001 – 90% 0010 – 80%, 0011 – 75% 0100 – 70%, 0101 – 65% 0110 – 60%, 0111 – 55% 1000 – 50%, 1001 – 45% 1010 – 40%, 1011 – 35% 1100 – 30%, 1101 – 25% 1110 – 20%, 1111 – 15%	0x00000000	MAX_HRZ_SIZE - 1
0x0628	Frame B WDR Bright Pixel Exposure (E1)	RW	<Bright Pixel Exposure Time (us)>	0x00000000	0x000FFFFFFF
0x062C	FrameB WDR Very-bright Pixel Exposure (E2)	RW	<Very Bright Pixel Exposure Time (us)>	0x00000000	0x000FFFFFFF
0x0664	Frame A WDR Ultra-bright Pixel Exposure (E2)	RW	<Ultra-Bright Pixel Exposure Time (us)>	0x00000000	0x000FFFFFFF

A.7 DUAL VIDEO REGISTERS AND FRAME A/B COMMON REGISTERS

Address	Register Name	Type	Usage	MIN Value	MAX Value
0x0718	Dual Video Frame A Repetition	RW	Number of Frame As to capture	0x00000000	0x000000FF
0x071C	Dual Video Frame B Repetition	RW	Number of Frame Bs to capture	0x00000000	0x000000FF
	Dual Video Line Time	RW	# Line Times	0x00000000	0x0000FFFF
0x0738	ADC Bit Depth	RW	00 – 8 bit, 01 – 10 bit, 02 – 12 bit	0x00000000	0x00000002
0x076C	Shutter mode	RW	00 – Rolling, 01 – Global	0x00000000	0x00000001
0x0770	Vertical Flip Output	RW	00 – off, 01 - enable	0x00000000	0x00000001
0x0774	Horizontal Flip Output	RW	00- Off, 01 – enable	0x00000000	0x00000001
0x0780	Dual / Tri-scan Readout	RW	00 – Dual Scan, 01 – Tri-Scan	0x00000000	0x00000001
0x07FC	Frame Mode Select	RW	00 – Frame A, 01 – Frame B, 10 – Dual Video, 11 – Dual Video Trigger	0x00000000	0x00000003

A.8 TRIGGER REGISTERS

Address	Register Name	Type	Usage	MIN Value	MAX Value
0x0650	Trigger Input Selector	RW	000 – IN1, 001 – IN2, 010 – CC1, 011 – CC2, 100 – PlsGen, 101 - Software	0x00000000	0x00000004
0x0654	Trigger Enable	RW	0 – enable, 1 - disable	0x00000000	0x00000001
0x0658	Trigger Edge Selector	RW	1 - Falling, 0 - Rising	0x00000000	0x00000001
0x065C	De-bounce Time Selector	RW	000 -, 001 - 10 μ s, 010 - 50 μ s, 011 - 100 μ s, 100 - 500 μ s, 101 - 1ms, 110 - 5ms, 111 - 10ms	0x00000000	0x00000007
0x6030	Software Trigger Single Pulse Generator	WO	Command	0x00000000	

A.9 PULSE GENERATOR REGISTERS

Address	Register Name	Type	Usage	MIN Value	MAX Value
0x0690	Pulse Gen. Granularity	RW	00 - 1x, 01 - 10x, 10 - 100x, 11 - 1000x	0x00000000	0x00000003
0x0694	Pulse Gen. Pulse Width	RW	<Pulse Width>	0x00000001	0x0007FFFF
0x0698	Pulse Gen. Pulse Period	RO	<Pulse Period>	0x00000001	0x000FFFFFFF
0x069C	Pulse Gen. # of Pulses	RW	<Number of Pulses>	0x00000001	0x0000FFFFFF
0x06A0	Pulse Gen. Enable	RW	1 - Enable, 0 - Disable	0x00000000	0x00000001

A.10 TEST PATTERN REGISTERS

Address	Register Name	Type	Usage	MIN Value	MAX Value
0x0428	Test Mode Selector	RW	000 – Disable 001 – H Ramp Static 010 – V Ramp Static 011 – H Ramp Moving 100 – V Ramp Moving 101 – Cross-Hair	0x00000000	0x00000005

A.11 STROBE REGISTERS

Address	Register Name	Type	Usage	MIN Value	MAX Value
0x0630	Strobe 1 Enable	RW	00 – disable, 01 – Enable Frame A only 10 – Enable Frame B only 11 – Enable Frame A & B	0x00000000	0x00000003
0x0634	Strobe 1 Start Reference	RW	0 – Exposure Start 1 – Readout Start	0x00000000	0x00000001
0x0638	Strobe 1 delay	RW	< S1 Delay Value (us)>	0x00000000	0x000FFFFFFF
0x063C	Strobe 1 duration	RW	<S1 Duration Value (us)>	0x00000000	0x000FFFFFFF
0x0640	Strobe 2 enable	RW	00 – disable, 01 – Enable Frame A only 10 – Enable Frame B only 11 – Enable Frame A & B	0x00000000	0x00000003
0x0644	Strobe 2 Start Reference	RW	0 – Exposure Start 1 – Readout Start	0x00000000	0x00000001
0x0648	Strobe 2 delay	RW	<S2 Delay Value (us)>	0x00000000	0x000FFFFFFF
0x064C	Strobe 2 Duration	RW	<S2 Duration Value (us)>	0x00000000	0x000FFFFFFF

A.12 INPUT AND OUTPUT REGISTERS

Address	Register Name	Type	Usage	MIN Value	MAX Value
0x0680	OUT1 Polarity Selector	RW	1 - Active H, 0 -Active L	0x00000000	0x00000001
0x0684	OUT1 Output Selector	RW	000 – no mapping 001 – trigger pulse 010 – pulse generator 011 – Strobe 1 100 – Strobe 2	0x00000000	0x00000003
0x0688	OUT2 Polarity Selector	RW	1 - Active H, 0 -Active L	0x00000000	0x00000001
0x068C	OUT2 Output Selector	RW	000 – no mapping 001 – trigger pulse 010 – pulse generator 011 – Strobe 1 100 – Strobe 2	0x00000000	0x00000003

A.13 OUTPUT DATA FORMAT REGISTERS

Address	Register Name	Type	Usage	MIN Value	MAX Value
0x040C	Bit Depth Selector	RW	000 - 8, 001 -10, 010 - 12	0x00000000	0x00000002
0x0424	Camera Link Output Selector	RW	000 - Single, 001 – Dual 010 – 4 Taps, 011 – 8 Taps, 100 – 10 Taps	0x00000000	0x00000005

A.14 WB AND COLOR CORRECTION REGISTERS

Address	Register Name	Type	Usage	MIN Value	MAX Value
0x0538	White Balance Mode	RW	00 - Off, 01 - Once, 10 – Auto Tracking, 11 – Manual	0x00000000	0x00000003
0x053C	AWB tracking speed	RW	000 – 1x slowest 001 – 2x 010 – 3x 011 – 4x 100 – 5x fastest	0x00000000	0x00000FFF
0x0540	WB Coef. Red	RW	<Value>	0x00000000	0x00000FFF
0x0544	WB Coef. Green	RW	<Value>	0x00000000	0x00000FFF
0x0548	WB Coef Blue	RW	<Value>	0x00000000	0x00000FFF

A.15 DATA CORRECTION REGISTERS

Address	Register Name	Type	Usage	MIN Value	MAX Value
0x0410	Look-Up-Table selector	RW	1 – LUT 2, 0 – LUT 1	0x00000000	0x00000001
0x0414	Look-Up-Table	RW	1 - Enable, 0 - Disable	0x00000000	0x00000001
0x0418	Defective Pixel Correction	RW	00 – Disable 01 – Static, 10 – Dynamic 11 – Static & Dynamic	0x00000000	0x00000003
0x041C	Hot Pixel Correction	RW	00 – Disable 01 – Static, 10 – Dynamic, 11 – Static & Dynamic	0x00000000	0x00000003
0x042C	Dynamic DPC Threshold	RW	<Value>	0x00000000	0x00000FFF
0x0430	Dynamic HPC Threshold	RW	<Value>	0x00000000	0x00000FFF

A.16 MANUFACTURING DATA REGISTERS

Address	Register Name	Type	Value
0x7004	Assembly Part Number	RO	<Assembly Part Number_1>
0x7008	Assembly Part Number	RO	<Assembly Part Number_2>
0x700C	Assembly Part Number	RO	<Assembly Part Number_3>
0x7010	Assembly Part Number	RO	<Assembly Part Number_4>
0x7014	Assembly Serial Number	RO	<Assembly Serial Number_1>
0x7018	Assembly Serial Number	RO	Assembly Serial Number_2
0x701C	CMOS Serial Number	RO	<CMOS Serial Number_1>
0x7020	CMOS Serial Number	RO	<CMOS Serial Number_2>
0x7024	Date of Manufacturer	RO	<Date of Manufacturer_1>
0x7028	Date of Manufacturer	RO	<Date of Manufacturer_2>
0x702C	Camera Type	RO	<Type of Camera_1>
0x7030	Camera Type	RO	<Type of Camera_2>
0x7034	Camera Type	RO	<Type of Camera_3>
0x7038	Camera Type	RO	<Type of camera_4>
0x7040	Sensor Type	RO	Mono – '0000000B', Bayer – '0000000C'

Appendix **B**

A large graphic for Appendix B, featuring a red and white chevron shape pointing downwards, with a grey chevron shape pointing upwards inside it, creating a diamond-like effect.

Creating Look-Up Tables

This appendix provides a reference on how to create a lookup table using both an ASCII editor and an Excel spreadsheet.

B.1 OVERVIEW

The Lookup Table file can be created using any standard ASCII text editor or by using Microsoft Excel. Additionally, any spreadsheet or mathematical program capable of generating a comma delimited (.csv) file can be used. See Appendix E for software load procedure.

B.2 USING AN ASCII TEXT EDITOR

A custom LUT (lookup table) can be prepared using any ASCII text editor, such as “Notepad” or similar. Alternatively, any spreadsheet program (i.e. Microsoft Excel) can be used by converting the spreadsheet into a comma delimited (.csv) file. In either case, the file must be renamed to include the .lut extension. The .lut file has two main sections: a header and a table. The ‘header’ section is a free text area of up to 256 ASCII characters. Each line of the header section must be terminated in a comma. The ‘table’ section of the file contains an array of 4096 lines with each line containing an input value followed by a comma and an output value. The input values represent incoming pixels and the output values represent what each incoming pixel should be converted into as an output pixel.

The format of the .LUT file is as follows:

```
-- Look Up Table input file example,  
-- lines beginning with two dashes are comments,  
-- and are ignored by parser,  
:Header,  
-- this is the text that will get displayed with a 'glh' command,  
Function is 'Negative Image',  
Created by John Doe,  
Date 1/14/09,  
:Table,  
-- input output,  
    0,4095  
    1,4094  
    2,4093  
    3,4092  
    4,4091  
    :  
    4095,0
```

B.3 USING MICROSOFT EXCEL

The .LUT file can be created in Excel as follows:

- 1 - create the spreadsheet as shown below (note that 4096 rows are required in the table).
- 2 - add the necessary equations into the output cells to generate the transfer function required.
- 3 - save the file as a .csv (comma delimited format).
- 4 - rename the .csv file to an extension of .lut.

	A	B	C	D	E	F	G	H	I	J	K	L	M	N	O
1	-- GAMMA CORRECTION LUT														
2	-- lines beginning with two dashes are comments														
3	-- and are ignored by parser														
4	:Header														
5	-- this is the text that will get displayed with a 'glh' command														
6	-- Function is 'Gamma Correction G=0.55'														
7	-- Created by Imperx														
8	-- Date 12/26/05														
9	--														
10	:Table														
11	-- This is User Selectable Gamma Value														
12	-- Sets Gamma G (G > 0)														
13															
14	-- This is the actual LUT														
15	--														
16		input	output												
17		0	0												
18		1	42												
19		2	61												
20		3	77												
21		4	90												
22		5	102												
23		6	113												
24		7	123												
25		8	132												
26		9	141												
27		10	149												
28		11	157												
29		12	165												
30		13	173												
31		14	180												
32		15	187												
33		16	193												
34		17	200												
35		18	206												
36		19	213												
37		20	219												
38		21	225												
39		22	231												
40		23	236												
41		24	242												
42		25	247												
43		26	253												
44		27	258												
45		28	263												
46		29	269												
47		30	274												
48		31	279												
49		32	284												
50		33	288												
		34	293												

Appendix

C

Creating DPC and HPC Tables

This appendix provides a reference on how to create a DPC and HPC table using an ASCII editor.

C.1 OVERVIEW

The Defective Pixel Map (DPM) and Hot Pixel Map (HPM) are provided with each camera. If the user wants to create its own DPM or HPM file, he/she can use any standard ASCII text editor or Microsoft Excel. Additionally, any spreadsheet or mathematical program capable of generating a comma delimited (.csv) file can be used.

C.2 USING AN ASCII TEXT EDITOR

A custom Defective Pixel Map (DPM) and Hot Pixel Map (HPM) can be prepared using any ASCII text editor, such as "Notepad" or similar. The file must have a .dpm extension for DPM map and .hpm extension for HPM. The .dpm (or .hpm) file has two main sections: a header and a table. The 'header' section is a free text area of up to 256 ASCII characters. Each line of the header section must be terminated in a comma. The 'table' section of the file contains an array of lines with each line containing an X (pixel number) value followed by a comma and a Y (line number) value. All pixels are listed in the DPM (or HPM) in order of increasing Y location. If the Y location is identical, the listing is in order of increasing X location. After editing save each file with the appropriate file extension. The maximum number of pixels in the DPM list is 128, and in HPM list is 1024.

Here is a simple example how to create a DPM. Create the DPM file with extension .dpm using "Notepad" or any other editing software. Locate the defective pixels in the camera and enter them in order starting with the smallest pixel number of the line number first. The file looks like this:

```
-- Defective Pixel Map,  
-- Date: 7/21/2013,  
-- Model#: CLB-B0610M,  
-- Serial#: 060380,  
:Table,  
-- Column(X) ,Row(Y)  
    4,1  
    588,1  
    78,5  
    82,27  
    405,300
```

Note.

In this example, the first table entry is pixel 4 from line 1, the next entry is pixel 588 from line 1, and the next entry is pixel 78 from line 5 and so on.

Appendix

D

Software Installation - CL

This appendix explains how to install the CHEETAH CamConfig software.

Use the following steps to install the CHEETAH Configurator software supplied on a USB stick. Note that 'click' refers to the left mouse button.

1. If a version of CHEETAH Configurator was previously installed on this machine, then you must first remove it:

To remove the application files:

- 1.1 Click on *"Start"*.
 - 1.2 Click on *"Settings"*.
 - 1.3 Click on *"Control Panel"*.
Double click on *"Add or Remove Programs"* for Windows XP or *"Programs and Features"* for Windows Vista and Windows 7.
 - 1.5 Click on *"CHEETAH Configurator"*.
 - 1.6 Click on *"Remove"*.
 - 1.7 If the 'CHEETAH Configurator – InstallShield Wizard' pops-up then do the following,
otherwise go to step 1.8:
Click on *"Remove"*.
Click *"Next"*.
Click *"Yes"*.
Click *"Finish"*.
 - 1.8 Click on *"Yes"*.
 - 1.9 Click on *"Close"*.
2. After having removed a previous version or if a version of CHEETAH Configurator was NOT previously installed on this machine then:

The first step is to install the application files:

- 2.1 Insert the CHEETAH Configurator USB stick into the appropriate drive; the setup.exe file will run automatically. Note: If it does not start automatically, click on *"Start"*, *"Run"*, enter or browse to *"(USB drive): setup.exe"* and click *"OK"*.
- 1.2 Wait for the "CHEETAH Configurator - InstallShield Wizard" screen to appear.
- 1.3 Follow the on-screen instructions.
- 2.4 Click *"Finish"*. This completes the software installation.
- 2.5 Reboot your computer.

For additional information and the latest updates and downloads, please visit our website at www.imperx.com

The graphic for Appendix E, featuring the word "Appendix" in a white, italicized, sans-serif font with a black outline, positioned to the left of a large, stylized letter "E". The "E" is white with a black outline and is set against a red diamond-shaped background with a white chevron pattern pointing downwards.

Power Supplies

This appendix has power supply models and connectors for CHEETAH series cameras.



Model: PS12V04A CHEETAH standard power supply ordered separately.



Trigger & Strobe pigtail with Male BNC connectors

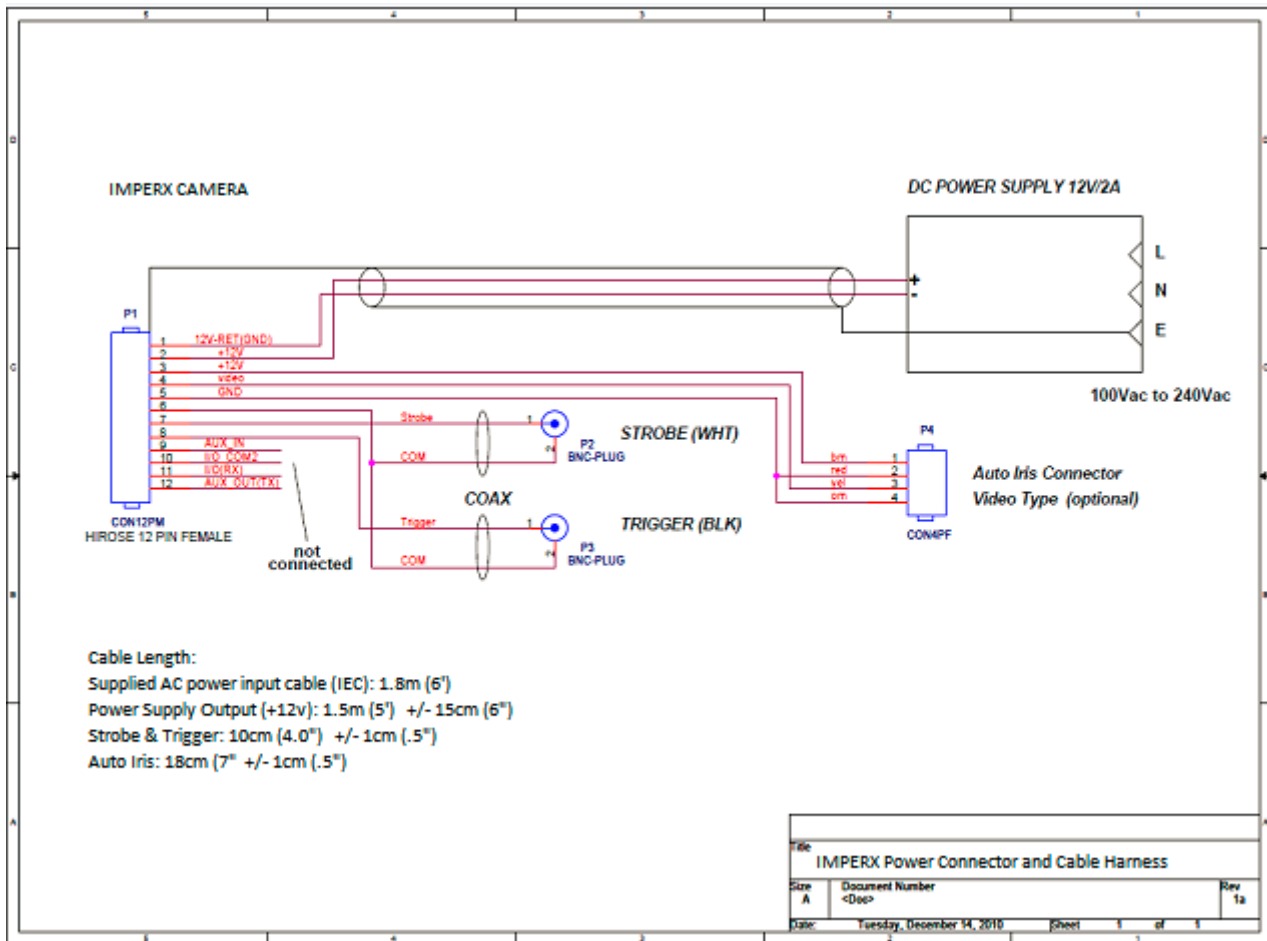

Power Supply Specs:

Cable length:

Supplied AC power input cable (IEC): 1.8m (6') 100 - 240 Vac, 50 - 60Hz 1A
 Power supply Output (+12V): 1.5m (5') ± 15cm (6") connector HIROSE #HR10A-10P-12S
 Strobe & Trigger: 10cm (4") ± 1cm (0.5") connector BNC male

Electrical:

Over-Voltage Protective Installation
 Short-circuit Protective Installation
 Protection Type: Auto-Recovery
 10 -15 VDC 12VDC nominal, 2 A.
 Load regulation ± 5%



Ripple & Noise 1% Max.

Regulatory:

Class 1

Safety standards UL60950-1,EN60950-1,IEC60950-1

Safety (1) EMC UL/CUL,CE,TUV,DoIR+C-Tick,Semko,CCC,FCC

Safety (2) BSMI,FCC